

Western Electric

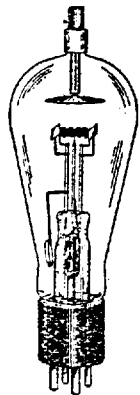
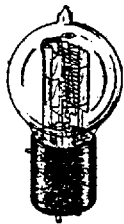
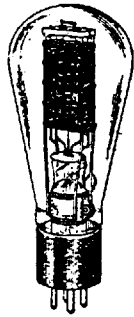

VACUUM TUBES

SECOND EDITION

for use with
AMATEUR
Radio Telephone
Transmitting
Equipments

Copyright, 1933, by
WESTERN ELECTRIC COMPANY, Inc.

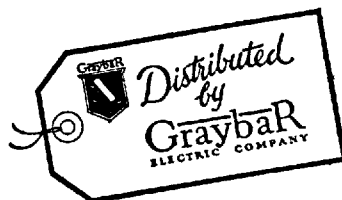

INTRODUCTION

THIS catalog supplies information on Western Electric Vacuum Tubes used with amateur Radio Telephone Transmitting Equipments.

Each double page is devoted to the presentation of information pertaining to a single tube. The information consists of a statement of the use or uses of the tubes, a table of electrical characteristics with associated notes; a line drawing showing the shape of the tube, its internal structure and its outside dimensions; a diagram indicating where the various leads appear in the base prongs or other connections; and the code numbers of the sockets with which the tube may be used.

The descriptions of tubes follow in numerical order.

101D Vacuum Tube

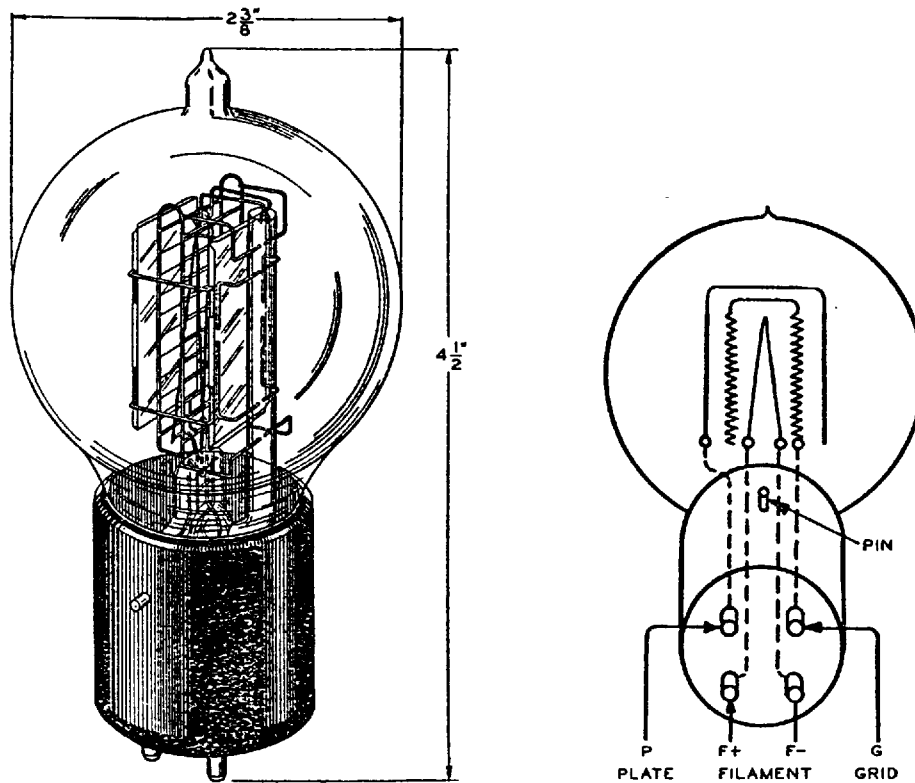

Classification

The No. 101D Vacuum Tube is a three-element filamentary type tube for use where small amounts of output power are required.

Base and Socket

The No. 101D Vacuum Tube employs a four-prong bayonet pin type base suitable for use in a Western Electric 100L (front panel mounting), 100R (rear panel mounting), or similar type socket.

Rating and Characteristic Data

Filament Current.....				1.0 Amperes
Filament Voltage.....				4.5 Volts
Plate Voltage.....	130	130	160	190 Max.
Grid Voltage.....	-9	-9	-14	-18
Average Plate Current—Milliamperes.....	7.4	7.4	7.35	8.35
Average Amplification Factor.....	6.0	6.0	6.0	5.95
Average Plate Resistance—Ohms.....	5700	5700	5800	5600
*Average Power Output—Milliwatts.....	65	60	135	230
Second Harmonic—% of Fundamental.....	5	3	4	5
Third Harmonic—% of Fundamental.....	0.4	0.2	0.4	0.5
Load Resistance—Ohms.....	5700	11400	11600	11200
*Input in peak values is equal to grid voltage.				

Approximate Direct Interelectrode Capacities (measured without socket)

Plate to Grid.....	5.0 MMF
Plate to Filament.....	2.0 MMF
Grid to Filament.....	3.7 MMF

Average Static Characteristics

The accompanying curves give the average static characteristics of the No. 101D Vacuum Tube.

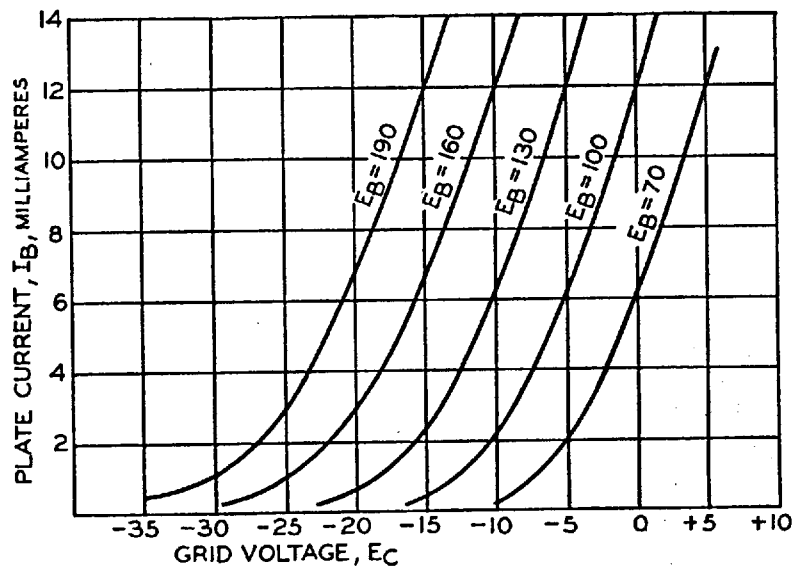

General Features

An average life of 40,000 hours is obtained when the No. 101D Tube is used in the equipment for which it was designed. This long life feature makes it very well suited for continuous operation where long uninterrupted service is desired.

The electrical characteristics for this tube are such that moderate power outputs are obtainable with small plate currents and with plate voltages under 200 volts. The characteristics of the No. 101D Tube are similar to those of the No. 101F, however, the No. 101D operates at a filament current of 1.0 ampere instead of 0.5 ampere.

101F Vacuum Tube

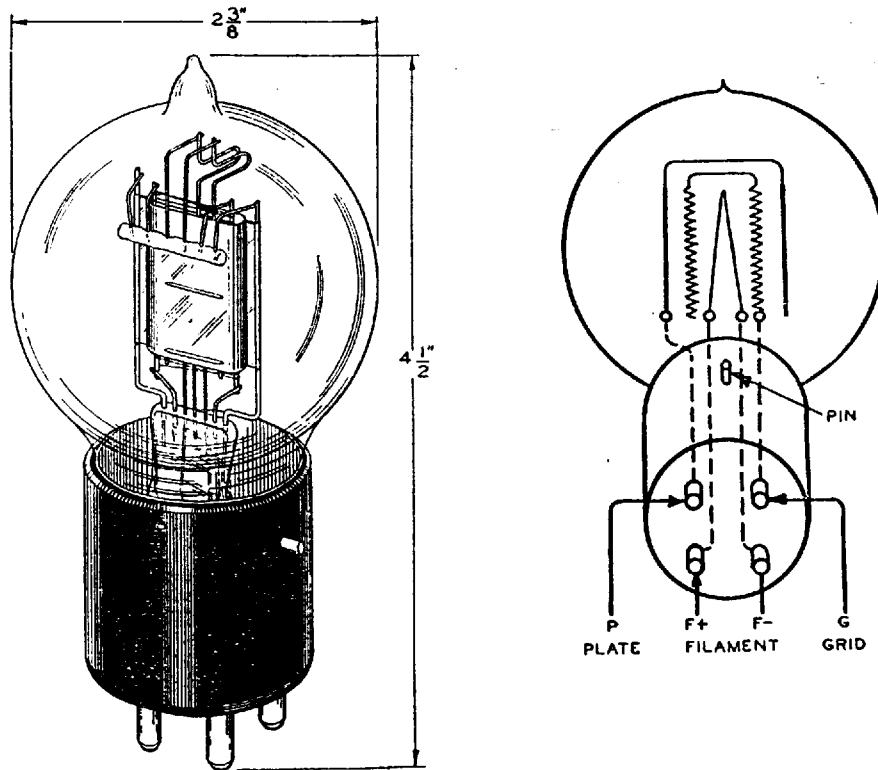

Classification

The No. 101F Vacuum Tube is a three-element filamentary type tube for use where small amounts of output power are required.

Base and Socket

The No. 101F Vacuum Tube employs a four-prong bayonet pin type base suitable for use in a Western Electric No. 100L (front panel mounting), No. 100R (rear panel mounting), or similar type socket.

Rating and Characteristic Data

Filament Current.....				.50 Ampere
Filament Voltage.....				4.1 Volts
Plate Voltage.....	130	130	160	190 Max.
Grid Voltage.....	-8	-8	-12	-16
Average Plate Current—Milliamperes.....	6.0	6.0	6.7	7.5
Average Amplification Factor.....	6.5	6.5	6.5	6.5
Average Plate Resistance—Ohms.....	5900	5900	5600	5400
*Average Power Output—Milliwatts.....	60	55	135	240
Second Harmonic—% of Fundamental.....	5	2	3	4
Third Harmonic—% of Fundamental.....	0.5	0.2	0.3	0.5
Load Resistance—Ohms.....	5900	11800	11200	10800

*Input in peak values is equal to grid voltage.

Approximate Direct Interelectrode Capacities (measured without socket)

Plate to Grid.....	5.9 MMF
Plate to Filament.....	3.7 MMF
Grid to Filament.....	5.2 MMF

Average Static Characteristics

The accompanying curves give the average static characteristics of the No. 101F Vacuum Tube.

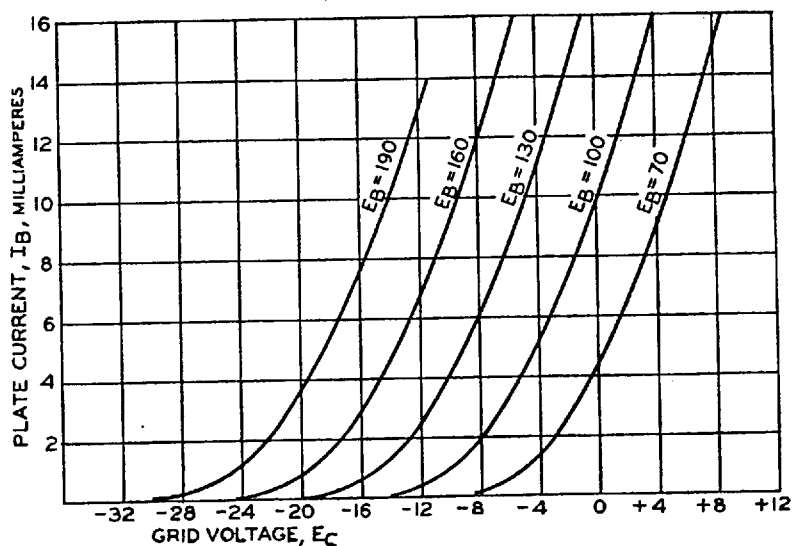

General Features

The No. 101F Vacuum Tube was designed for use where a very long life is essential. This makes it particularly suitable for applications where continuous service is desired. The microphonic response of this tube is low.

The electrical characteristics are such that moderate power outputs are obtainable with small plate currents and with plate voltage under 200 volts.

The characteristics are similar to those of the No. 101D, however, the No. 101F operates at a filament current of 0.5 instead of 1.0 ampere.

205D Vacuum Tube

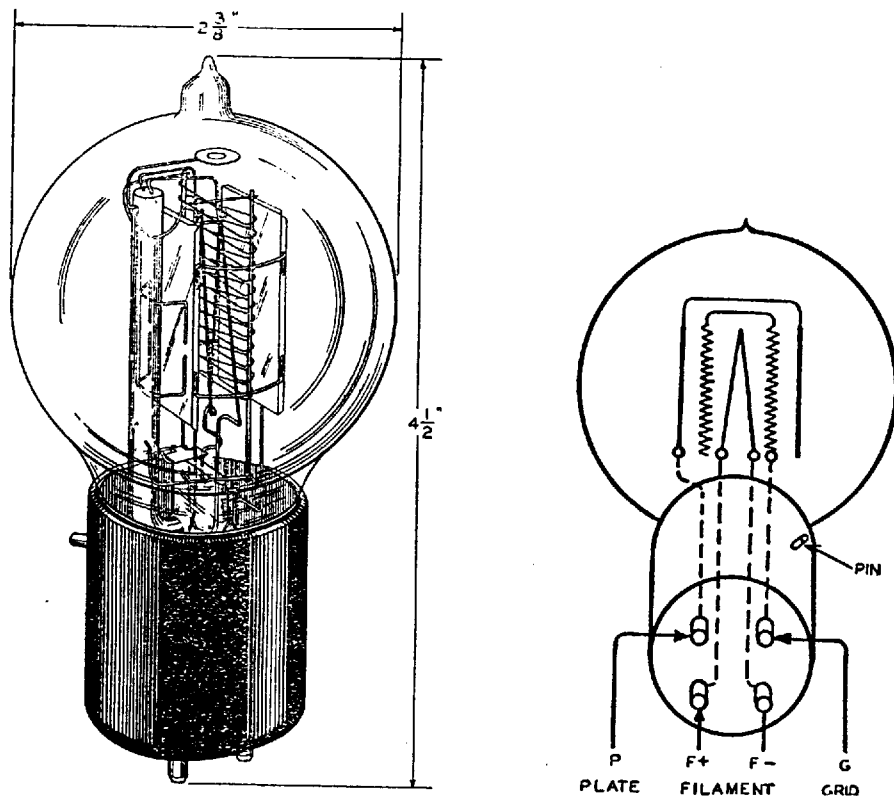

Classification

The No. 205D is a three-element filamentary type tube intended for use as a radio-frequency amplifier, oscillator, modulator, and audio-frequency amplifier in output stages when moderate powers are required.

Base and Socket

The No. 205D Vacuum Tube employs a four-prong bayonet pin type base suitable for use in a Western Electric 100M (front panel mounting), 115B (rear panel mounting), or similar type socket.

General Ratings and Information

Filament Voltage.....	4.5 Volts, AC or DC
Filament Current.....	1.6 Amperes
Average Amplification Factor.....	7.3
Approximate Direct Interelectrode Capacities (measured without socket)	
Plate to Grid.....	4.8 MMF
Plate to Filament.....	3.3 MMF
Grid to Filament.....	5.2 MMF
Audio-Amplifier or Modulator Rating—Peak Grid Input Equal to or less than grid Bias—Class A Service.	
Maximum Plate Voltage.....	400 Volts
Maximum Plate Current.....	50 Milliamperes
Maximum Plate Dissipation.....	14 Watts

Typical outputs obtainable within the recommended operating conditions for resistance loads equal to twice the plate resistance and for inputs on the grid equal to the grid bias.

Plate Volts	Grid Volts	Approx. Plate Current (Milli-amperes)	Approx. Plate Resistance Rp (Ohms)	Fundamental Power Output (Milli-watts)	Second Harmonic % of Funda. Output	Third Harmonic % of Funda. Output
250	-10	27.5	4000	160	1.5	.1
300	-24	15	5000	670	5.5	.5
	-18	25	4150	480	3.0	.2
350	-22.5	30	3900	800	3.0	.3
	-20	35	3750	675	2.5	.2
370	-30	21	4450	1200	5.0	.5

When two tubes are operated in a push-pull circuit the second harmonic in the output is reduced by the balancing action in the circuit. Due to the uniformity in the characteristics of the No. 205D Tube the second harmonic output, in the push-pull circuit, is reduced to the general level of the third harmonic output. With a plate voltage of 375 volts, and a total plate current of approximately 42 milliamperes, two No. 205D Tubes will give 2.4 watts output with a total harmonic content of the order of 1.0 per cent.

Radio-Frequency Amplifier—Grid Bias practically at Plate Cut-Off—Class B Service.

Maximum Plate Voltage.....	400 Volts
Maximum DC Plate Current.....	50 Milliamperes
Maximum Plate Dissipation.....	14 Watts
Peak Power Output.....	12 Watts

Oscillator or Radio-Frequency Amplifier—Grid Bias greater than Plate Current Cut-Off—Class C Service.

Maximum Non-modulated DC Plate Voltage.....	400 Volts
Maximum Modulated DC Plate Voltage.....	350 Volts
Maximum DC Plate Current.....	50 Milliamperes
Maximum Plate Dissipation.....	14 Watts
Peak Power Output.....	12 Watts

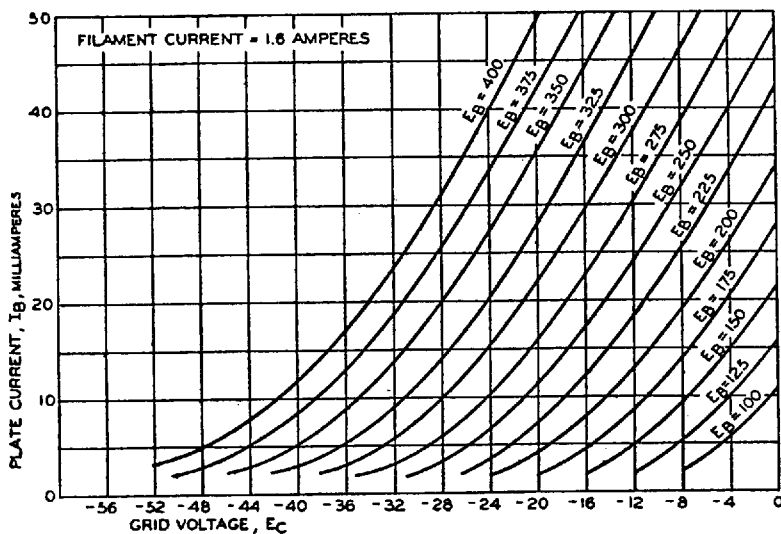

Average Static Characteristics

The accompanying curve gives the average static characteristics for the No. 205D Tube. These curves have been obtained with the filament operating on direct current and the grid and plate returns connected to the negative ends of the filament.

General Features

The No. 205D Tube will operate satisfactorily at or above 30,000 kilocycles if the radio-frequency charging current is limited to a value that will not cause excessive heating of the lead-in wires or di-electric parts.

The filament is of a particularly rugged oxide coated type insuring a long tube life.

205E Vacuum Tube

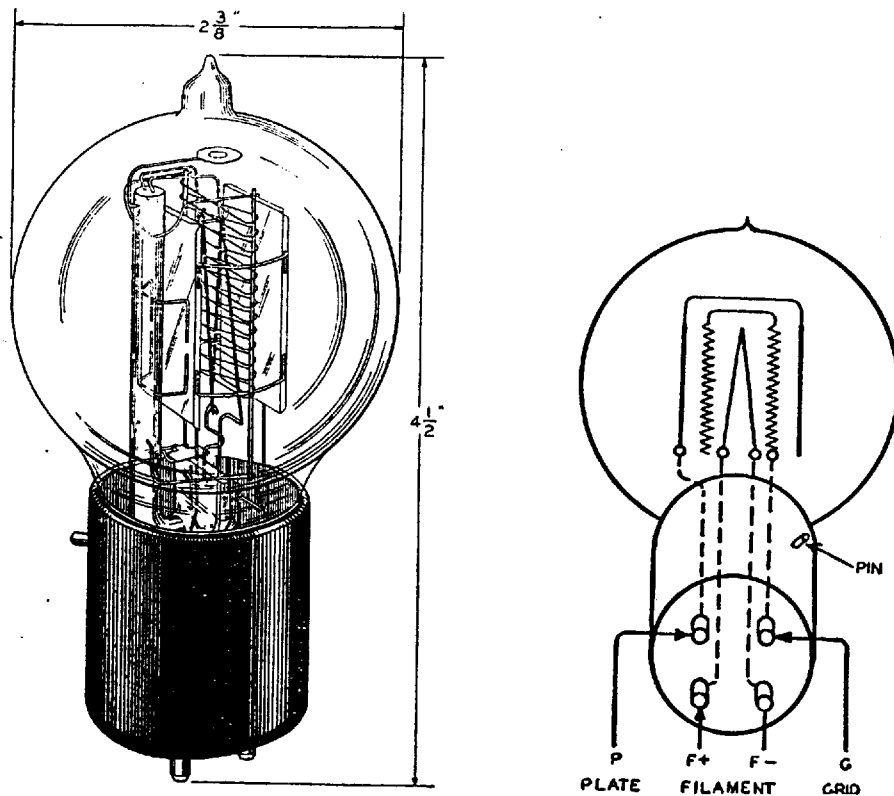

Classification

The No. 205E is a three-element filamentary type tube intended for use as a radio-frequency amplifier, oscillator, modulator, and audio-frequency amplifier in output stages when moderate powers are required.

Base and Socket

The No. 205E Vacuum Tube employs a four-prong bayonet pin type base suitable for use in a Western Electric 100M (front panel mounting), 115B (rear panel mounting), or similar type socket.

General Ratings and Information

Filament Voltage.....	4.5 Volts, AC or DC
Filament Current.....	1.6 Amperes
Average Amplification Factor.....	7.3

Approximate Direct Interelectrode Capacities (measured without socket)

Plate to Grid.....	4.8 MMF
Plate to Filament.....	3.3 MMF
Grid to Filament.....	5.2 MMF

Audio-Amplifier or Modulator Rating—Peak Grid Input Equal to or less than grid Bias—Class A Service.

Maximum Plate Voltage.....	400 Volts
Maximum Plate Current.....	50 Milliampers
Maximum Plate Dissipation.....	14 Watts

Typical outputs obtainable within the recommended operating conditions for resistance loads equal to twice the plate resistance and for inputs on the grid equal to the grid bias.

Plate Volts	Grid Volts	Approx. Plate Current (Milli-amperes)	Approx. Plate Resistance Rp (Ohms)	Fundamental Power Output (Milli-watts)	Second Harmonic. % of Funda. Output	Third Harmonic. % of Funda. Output
250	-10	27.5	4000	160	1.5	.1
300	-24	15	5000	670	5.5	.5
	-18	25	4150	480	3.0	.2
350	-22.5	30	3900	800	3.0	.3
	-20	35	3750	675	2.5	.2
370	-30	21	4450	1200	5.0	.5

When two tubes are operated in a push-pull circuit the second harmonic in the output is reduced by the balancing action in the circuit. Due to the uniformity in the characteristics of the No. 205E tube the second harmonic output, in the push-pull circuit, is reduced to the general level of the third harmonic output. With a plate voltage of 375 volts and a total plate current of approximately 42 milliamperes, two No. 205E tubes will give 2.4 watts output with a total harmonic content of the order of 1.0 per cent.

Radio-Frequency Amplifier—Grid Bias practically at Plate Cut-Off—Class B Service.

Maximum Plate Voltage.....	400 Volts
Maximum DC Plate Current.....	50 Milliamperes
Maximum Plate Dissipation.....	14 Watts
Peak Power Output.....	12 Watts

Oscillator or Radio-Frequency Amplifier—Grid Bias greater than Plate Current Cut-Off—Class C Service.

Maximum Non-modulated DC Plate Voltage.....	400 Volts
Maximum Modulated DC Plate Voltage.....	350 Volts
Maximum DC Plate Current.....	50 Milliamperes
Maximum Plate Dissipation.....	14 Watts
Peak Power Output.....	12 Watts

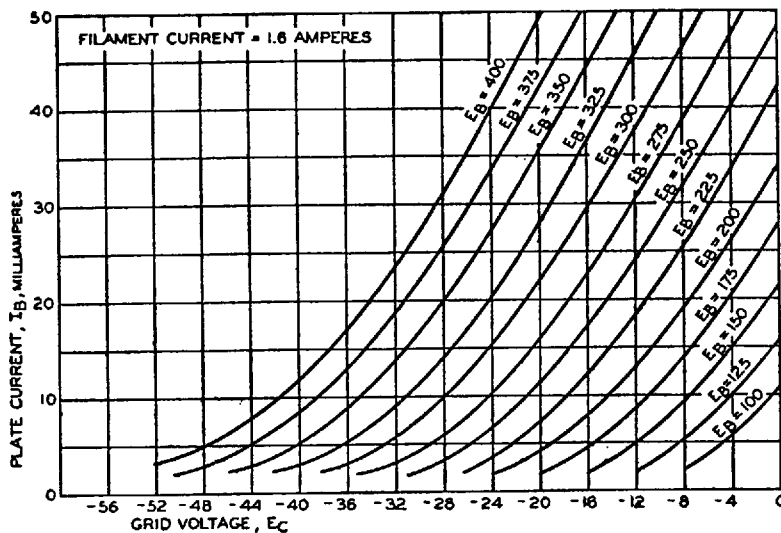

Average Static Characteristics

The accompanying curve gives the average static characteristics for the No. 205E Tube. These curves have been obtained with the filament operating on direct current and the grid and plate returns connected to the negative ends of the filament.

General Features

The No. 205E Tube will operate satisfactorily at or above 30,000 kilocycles if the radio frequency charging current is limited to a value that will not cause excessive heating of lead-in wires or di-electric parts.

It is similar to the No. 205D except that the internal structure is designed to reduce noise disturbance outputs due to variable contacts within the tube. The prongs of the base are equipped with special contact metal tips to prevent noise disturbance due to poor electrical contact with the springs of the socket.

The filament is of a particularly rugged oxide coated type insuring a long tube life.

215A Vacuum Tube

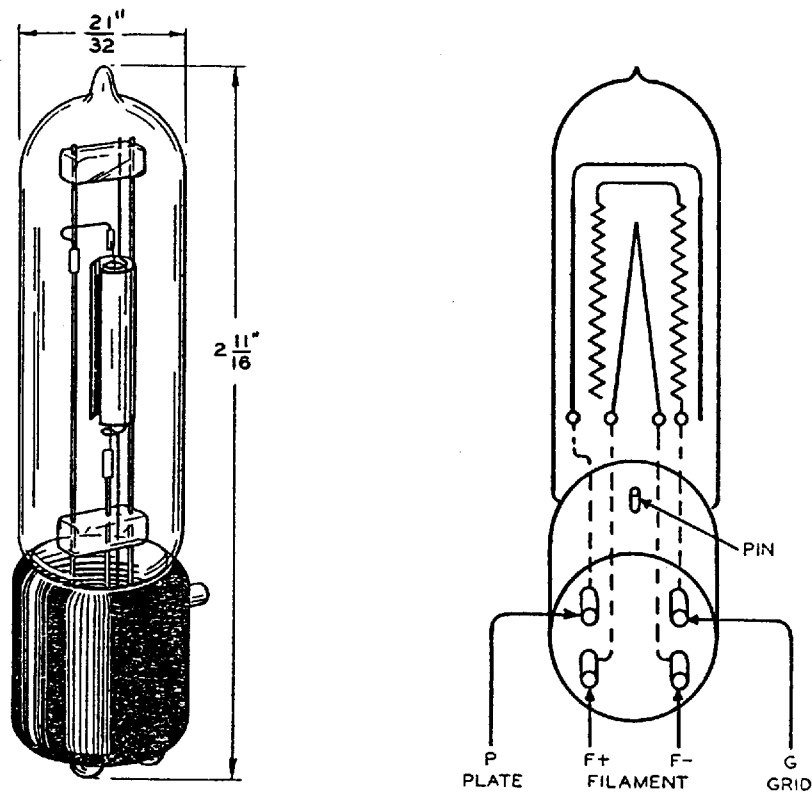

Classification

The No. 215A is a three-element filamentary type tube which may be used as a detector or amplifier in applications requiring a tube of small size and low power consumption.

Base and Socket

The No. 215A employs a small four-prong bayonet pin type base suitable for use in a Western Electric No. 125B or similar type socket. The arrangement of electrode connections to the base terminals is shown above.

Rating and Characteristic Data

Filament Voltage.....		1.0 Volts
Filament Current.....		0.25 Ampere, DC
Plate Voltage.....	60	100 Volts Maximum
Grid Voltage.....	-3.0	-10.0 Volts
Average Plate Current.....	1.80	1.90 Milliamperes
Average Plate Resistance.....	13,700	14,800 Ohms
Average Amplification Factor.....	5.8	5.6

Approximate Direct Interelectrode Capacities

Plate to Grid.....	2.6 MMF
Plate to Filament.....	1.2 MMF
Grid to Filament.....	1.6 MMF

Average Static Characteristics

The accompanying curves give the average static characteristics of the No. 215A Vacuum Tube.

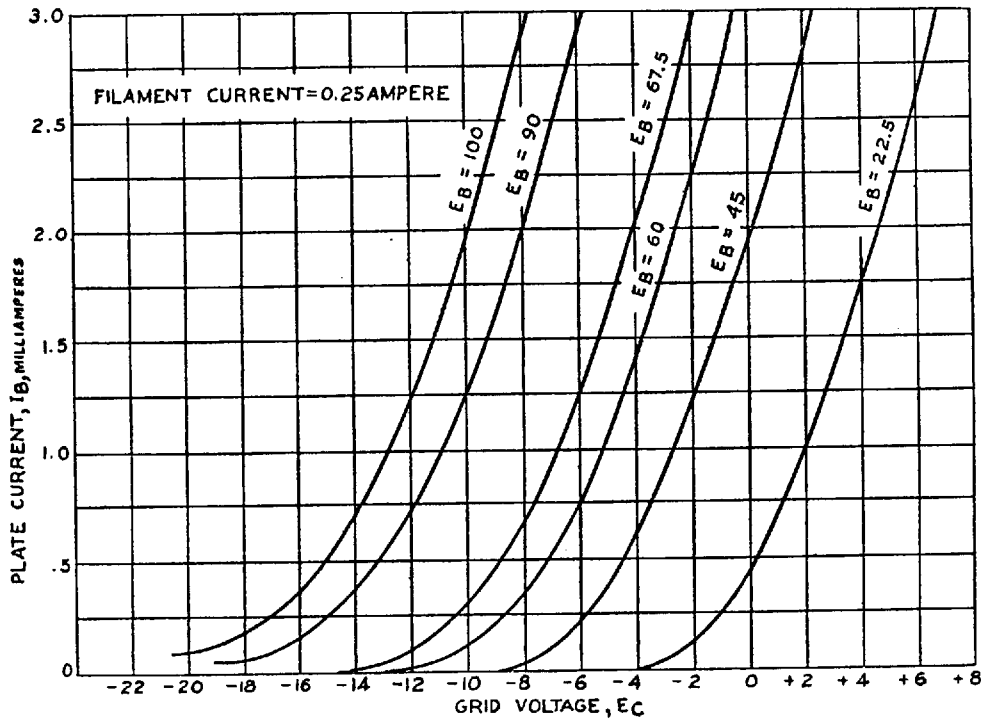

General Features

The No. 215A Vacuum Tube is the smallest Western Electric coded tube, its overall length being only 2 $\frac{1}{4}$ ". This, together with its low power consumption makes it particularly adaptable in portable equipment where compactness is essential.

It has a rugged filament which gives ample electron emission to insure uniform characteristics over a long life.

231D Vacuum Tube

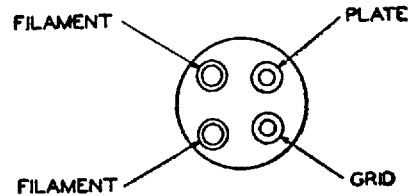
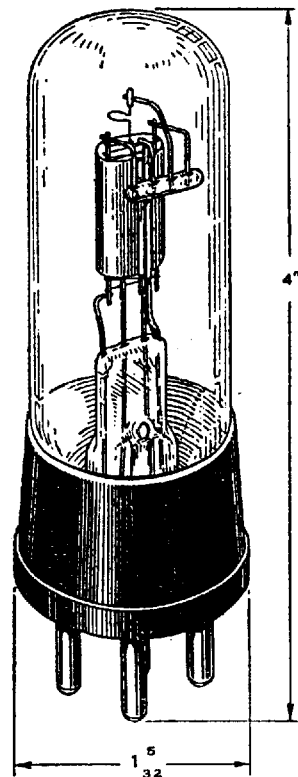

Classification

The No. 231D Vacuum Tube is a three-element filament type tube for use as an audio-frequency amplifier in the first and intermediate stages requiring a low filament power consumption.

Base and Socket

The No. 231D Vacuum Tube employs a standard four-prong, thrust-type base suitable for use in a Western Electric No. 130B (rigid) or No. 131A (cushion) Socket or similar type socket. The arrangement of electrode connections to the base terminals is shown above.

Rating and Characteristic Data

Filament Voltage.....		2.9 to 3.4 Volts, DC
Average Filament Current.....		0.060 Ampere
Plate Voltage.....	90	135 Volts Maximum
Grid Voltage.....	-3.0	-7.5 Volts
Average Plate Current.....	2	2.5 Milliamperes
Average Plate Resistance.....	15,600	14,600 Ohms
Average Amplification Factor.....	7.8	7.8

Approximate Direct Interelectrode Capacities

Plate to Grid.....	3.2 MMF
Plate to Filament.....	2.5 MMF
Grid to Filament.....	2.4 MMF

Average Static Characteristics

The accompanying curves give the average static characteristics of the No. 231D Vacuum Tube.

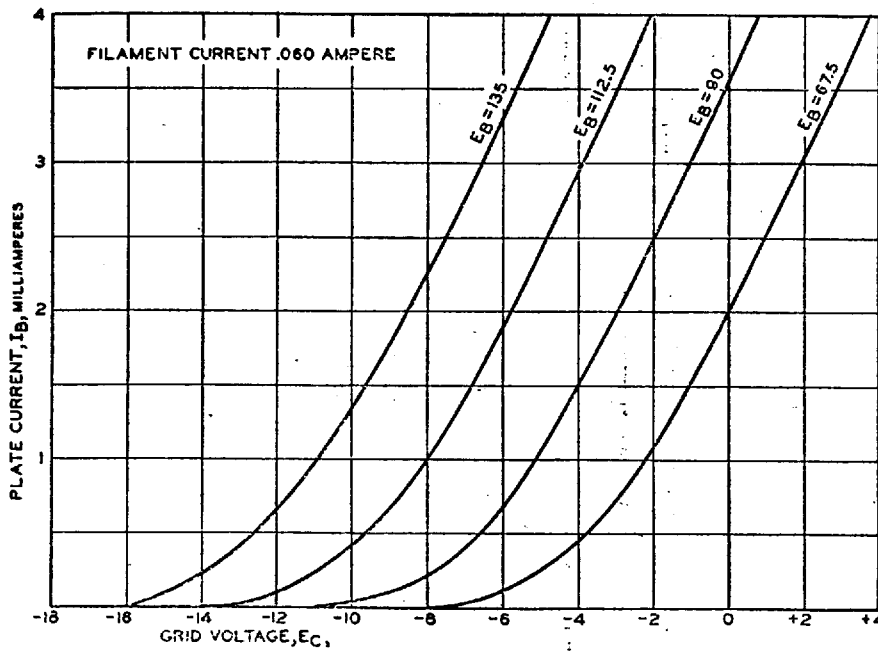

General Features

The very low power consumed by the filament of the No. 231D Vacuum Tube makes it particularly adaptable for use in portable equipment or wherever a low current drain is necessary.

By careful control of the manufacturing processes, uniform characteristics are obtained over an unusually long life for a filament of such small size.

242A Vacuum Tube

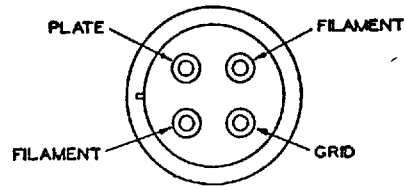
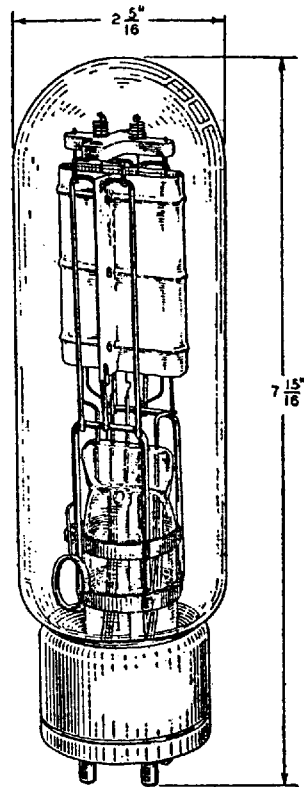

Classification

The No. 242A Vacuum Tube is a three-element tube used as an oscillator, radio-frequency amplifier, modulator or audio-frequency amplifier.

Base and Socket

The No. 242A Vacuum Tube employs a standard four-prong, bayonet pin type base suitable for use in a Western Electric 112A socket or similar type socket. The arrangement of electrode connections to the base terminals is shown above.

Ratings and Characteristic Data

Filament Voltage.....	10 Volts
Nominal Filament Current.....	3.25 Amperes
Maximum Plate Voltage.....	1,250 Volts
Maximum Plate Current.....	0.150 Ampere
Average Plate Resistance.....	3,500 Ohms
Average Amplification Factor.....	12.5
Approximate Direct Interelectrode Capacities	
Plate to Grid.....	13.0 MMF
Plate to Filament.....	4.0 MMF
Grid to Filament.....	6.5 MMF
Audio-Amplifier or Modulator Rating—Peak Grid Drive equal to or less than the Bias	
—Class A Service	
Maximum Plate Voltage.....	1000
Maximum Plate Current.....	0.85 Ampere
Maximum Plate Dissipation.....	85 Watts
Grid Bias Voltage.....	—50 Volts
Load Impedance.....	7,000 Ohms
Undistorted Output.....	10 Watts

Radio-Frequency Amplifier—Grid Bias practically at Cut-Off, Grid Drive higher than the Bias—Class B Service

Maximum Plate Voltage.....	1,250
Maximum Plate Current.....	0.150 Ampere
Maximum Plate Dissipation.....	100 Watts
Grid Bias Voltage.....	—100 Volts
Peak Output.....	125 Watts

Oscillator or Radio-Frequency Amplifier—Grid Bias below Cut-Off—Class C Service

Maximum Modulated Plate Voltage (DC).....	1,000 Volts
Maximum Non-modulated Plate Voltage (DC).....	1,250 Volts
Maximum Plate Current.....	0.150 Ampere
Maximum Plate Dissipation.....	100 Watts
Maximum Radio-Frequency Charging Current in Grid and Plate Leads.....	5 Amperes
Approximate Grid Bias.....	—150 Volts
Maximum Output.....	125 Watts

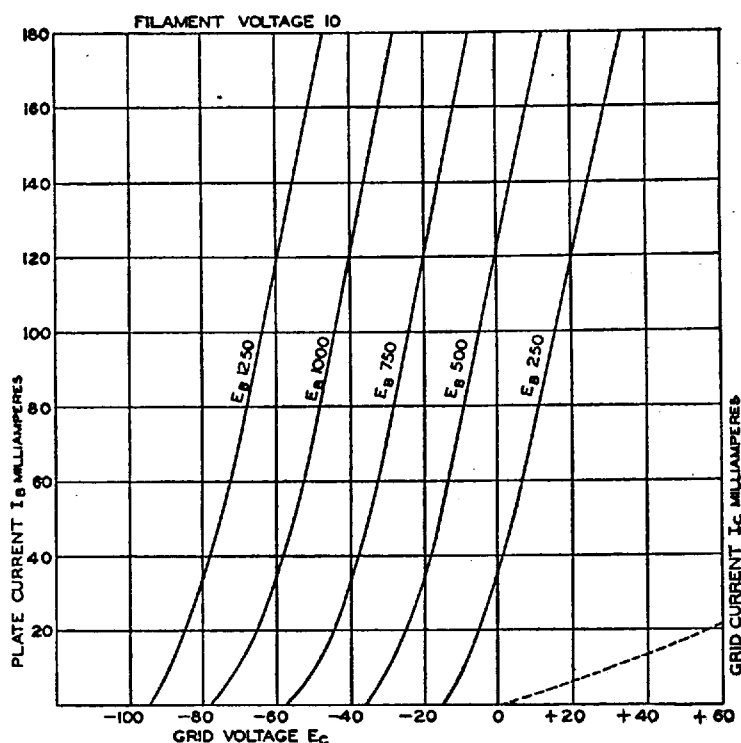

Average Static Characteristics

The accompanying curves give the average static characteristics of the No. 242A Vacuum Tube. These curves are taken with the filament operating on alternating current and with the plate and grid returns connected to a center point of the filament transformer.

General Features

The No. 242A Vacuum Tube has an unusually rugged type of structure which insures against breakage in shipment and in service and makes possible the maintenance of uniform electrical characteristics.

The manufacturing process control, long aging together with an adequate thoriated tungsten filament, insure this tube of electrical stability and extremely long life when operated under rated conditions.

244A Vacuum Tube

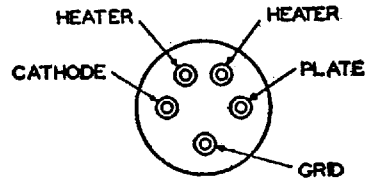
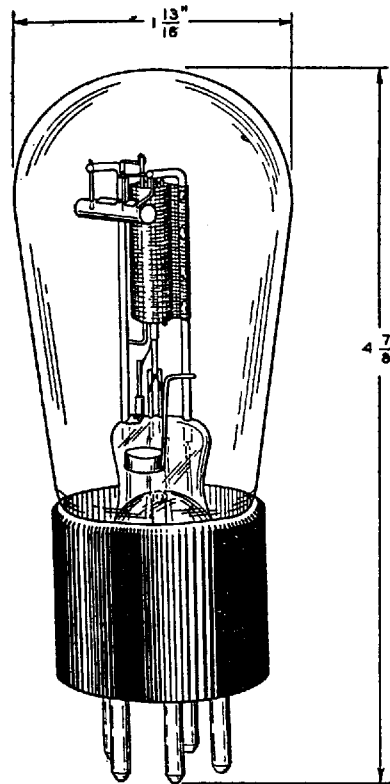

Classification

The No. 244A Vacuum Tube is a general purpose tube having an indirectly heated cathode which permits operation of the heater element directly on alternating current. The tube is for use as an audio-frequency amplifier in intermediate stages but may also be used satisfactorily as a power amplifier tube for applications requiring small values of output power.

Base and Socket

The No. 244A Vacuum Tube employs a standard five-prong base suitable for use in a Western Electric No. 134A (cushion) or No. 137A (rigid) socket or similar type socket. The arrangement of electrode connections to the base terminals is shown above.

Rating and Characteristic Data

Heater Voltage.....		2 Volts, AC or DC
Average Heater Current.....		1.6 Amperes
Plate Voltage.....	135	180 Volts Maximum
Grid Voltage.....	-6	-10 Volts
Average Plate Current.....	5.5	6.0 Milliamperes
Average Plate Resistance.....	10,000	10,000 Ohms
Average Amplification Factor.....	10.0	9.7

Approximate Direct Interelectrode Capacities

Plate to Grid.....	3.3 MMF
Plate to Cathode.....	3.7 MMF
Grid to Cathode.....	3.8 MMF

Average Static Characteristics

The accompanying curves give the average static characteristics of the No. 244A Vacuum Tube.

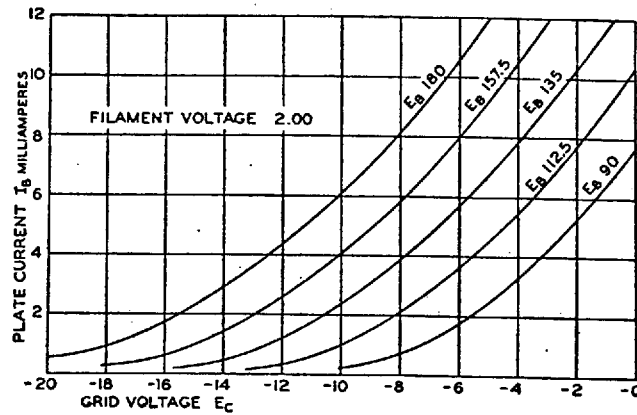

General Features

The No. 244A Vacuum Tube is rugged in construction which insures it against breakage in shipment and in service.

The cathode is designed to have a very large electron emission compared with the space current drain.

These features together with careful control of the manufacturing processes make possible the maintenance of uniform electrical characteristics over a very long life.

247A Vacuum Tube

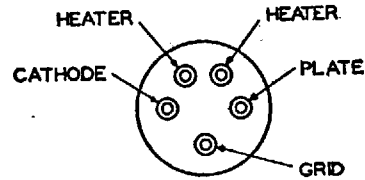
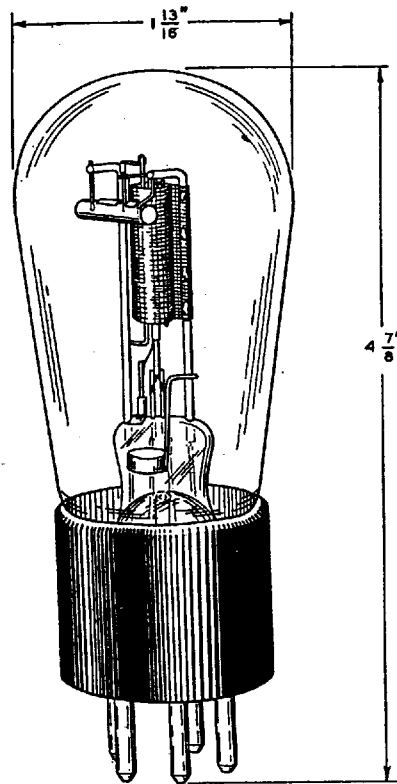

Classification

The No. 247A Vacuum Tube is a general purpose tube having an indirectly heated cathode which permits operation of the heater element directly on alternating current. The tube is for use as an audio-frequency amplifier in intermediate stages but may also be used satisfactorily as a power amplifier tube for applications requiring small values of output power.

Base and Socket

The No. 247A Vacuum Tube employs a standard five-prong base suitable for use in a Western Electric No. 134A (cushion) or No. 137A (rigid) socket or similar type socket. The arrangement of electrode connections to the base terminals is shown above.

Rating and Characteristic Data

Heater Voltage.....	2 Volts, AC or DC
Average Heater Current.....	1.6 Amperes
Plate Voltage.....	135 180 Volts Maximum
Grid Voltage.....	-4.5 -7 Volts
Average Plate Current.....	3.25 3.80 Milliamperes
Average Plate Resistance.....	16,200 16,000 Ohms
Average Amplification Factor.....	14.9 14.6

Approximate Direct Interelectrode Capacities

Plate to Grid.....	3.2 MMF
Plate to Cathode.....	2.7 MMF
Grid to Cathode.....	3.4 MMF

Average Static Characteristics

The accompanying curves give the average static characteristics of the No. 247A Vacuum Tube.

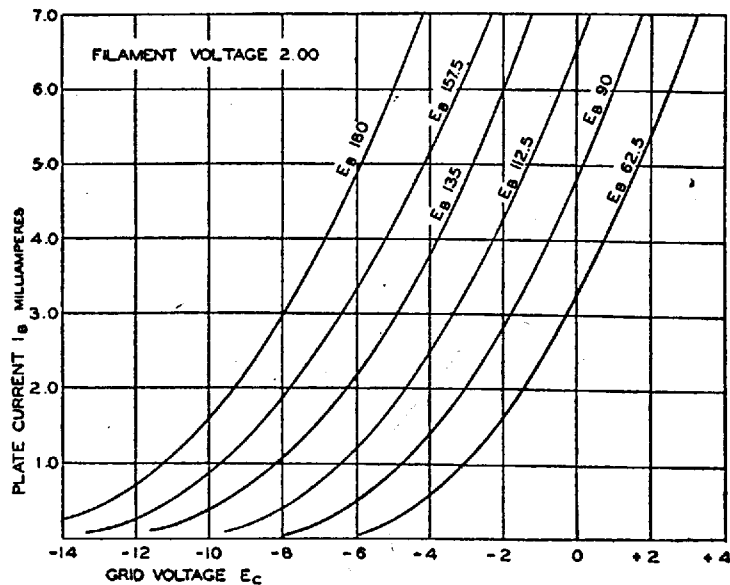

General Features

The low plate current drain of the No. 247A Vacuum Tube makes it particularly adaptable for use in intermediate stages of audio-frequency amplifiers when resistance coupling is used. However, its plate resistance is sufficiently low that it is also well adapted for use with transformer coupling.

The total electron emission of the cathode is very large compared with the maximum space current drain. This together with special features of design and careful control of the manufacturing processes enables this tube to meet exacting service requirements throughout a very long life.

249A Vacuum Tube

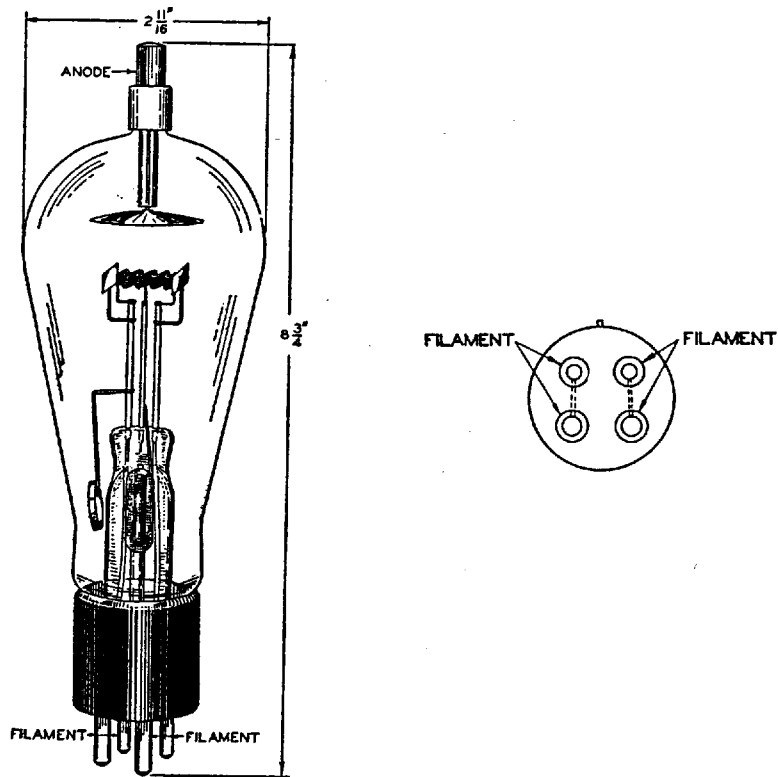

Classification

The No. 249A Vacuum Tube is a half-wave, thermionic, mercury-vapor rectifier for use in rectifying circuits designed to supply direct current from an alternating current supply.

Base and Socket

The No. 249A Vacuum Tube employs a standard four-prong thrust-type base suitable for use in the Western Electric No. 130B or similar type socket. It is to be noted from the arrangement of electrode terminals shown above that the filament terminals are tied together in parallel. The corresponding socket terminals should also be connected to insure the best contact connections for the filament current. The anode terminal is located at the top of the bulb and is arranged for a special quick release connector. The tube can be mounted only in a vertical position with the base end down.

Rating and Characteristic Data

Filament Voltage	2.5 Volts, AC
Nominal Filament Current	7.0 Amperes
Approximate Anode-Cathode Potential Drop when Conducting .	15 Volts
Maximum Peak Plate Current.....	1.1 Amperes
Maximum Peak Inverse Potential.....	6,500 Volts
Safe Operating Ambient Temperature	0 to 50 Degrees C

The anode-cathode potential is substantially independent of the plate current. The exact value varies from tube to tube and during the life of a given tube. Within the specified ambient temperature range and plate current range, it will vary from 5 to 25 volts.

Typical Rectifying Circuits

For specific circuits the following ratings apply:

Type of Circuit	Number Tubes	Load Potential Volts	Load Current Amperes
Single-Phase, Half-Wave.....	1	2,000	0.4
Single-Phase, Double Half-Wave.....	2	2,000	0.8
Single-Phase, Double Half-Wave (Four Tube Series Circuit).....	4	4,000	0.8
Three-Phase (Six Tube Series "Y" Circuit).....	6	6,000	1.0

General Features

The mercury vapor type of rectifying tube has the desirable property of a low and almost constant potential drop between the cathode and anode when the tube is passing current. Due to their low potential drop a much more efficient rectifier system can be had than is possible by the use of high vacuum rectifier tubes, whose potential drop are relatively high. The constancy of the potential drop with space current makes possible rectifying systems whose regulation depends almost entirely on the regulation of the plate transformers.

The No. 249A Vacuum Tube employs a highly efficient oxide-coated type of cathode. Its mechanical construction is such that the active materials are maintained for long operating periods as well as during shelf life and shipment.

252A Vacuum Tube

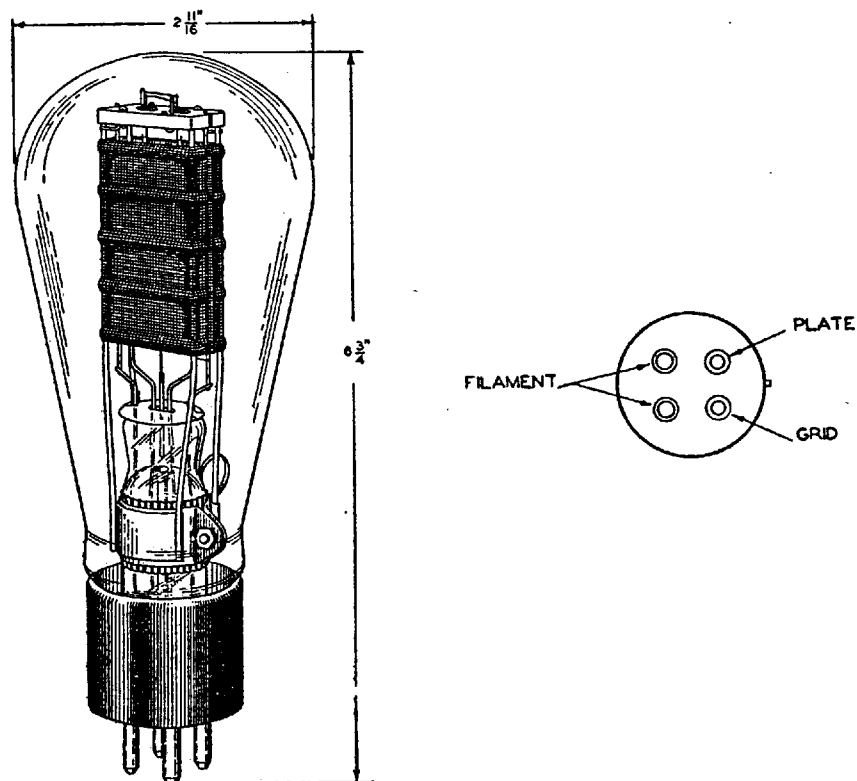

Classification

The No. 252A Vacuum Tube is a three-element tube having a filamentary type of cathode. The tube is for use as an audio-frequency amplifier in output stages where moderate powers are required. It may also be used as an oscillator or modulator.

Base and Socket

The No. 252A Vacuum Tube employs a standard four-prong, thrust-type base suitable for use in a Western Electric No. 130B (rigid) or No. 131A (cushion) socket or similar type socket. The arrangement of electrode connections to the base terminals is shown above.

Rating and Characteristic Data

Filament Voltage.....	5 Volts, AC or DC
Average Filament Current.....	2 Amperes
For Fixed Grid Bias	
Maximum Plate Voltage.....	450 Volts
Maximum Grid Bias.....	-65 Volts
Average Plate Current.....	43 Milliamperes
Average Plate Resistance.....	1,700 Ohms
Average Amplification Factor.....	5.0
For Self-Biasing Grid	
Maximum Plate Voltage.....	450 Volts
Maximum Grid Bias.....	-60 Volts
Average Plate Current.....	60 Milliamperes
Average Plate Resistance.....	1,500 Ohms
Average Amplification Factor.....	5.1
Approximate Direct Interelectrode Capacities	
• Plate to Grid.....	12.0 MMF
Plate to Filament.....	4.0 MMF
Grid to Filament.....	6.5 MMF

Average Static Characteristics

The accompanying curves give the average static characteristics of the No. 254A Vacuum Tube. These curves are taken with the filament operating on alternating current with the plate, screen and control grid circuit returns connected to a midpoint of the filament transformer.

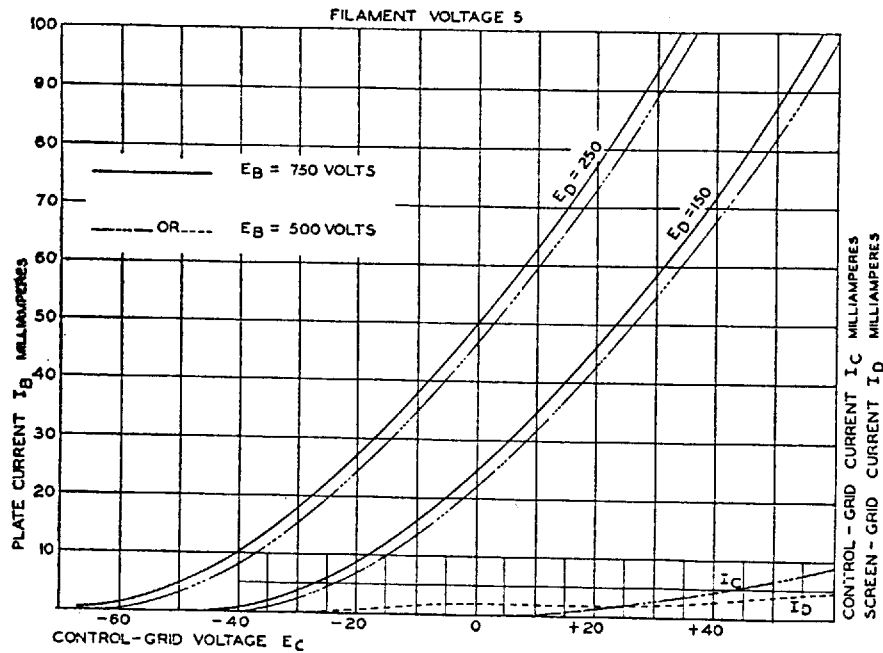

General Features

The No. 254A Vacuum Tube employs an extra grid or screen which provides an electrostatic shield between the plate and control grid. When the potential of the screen is held constant, variations of the plate potential have little effect upon the potential fields around the inner electrodes. Such internal shielding eliminates the necessity of neutralization to prevent unwanted oscillations or feedback if the rest of the circuit elements are properly shielded.

The thoriated tungsten filament of this tube is made in a spiral of such form as to maintain the tube internal impedance low and constant during its life. The mechanical structure has adequate strength for severe usages.

254B Vacuum Tube

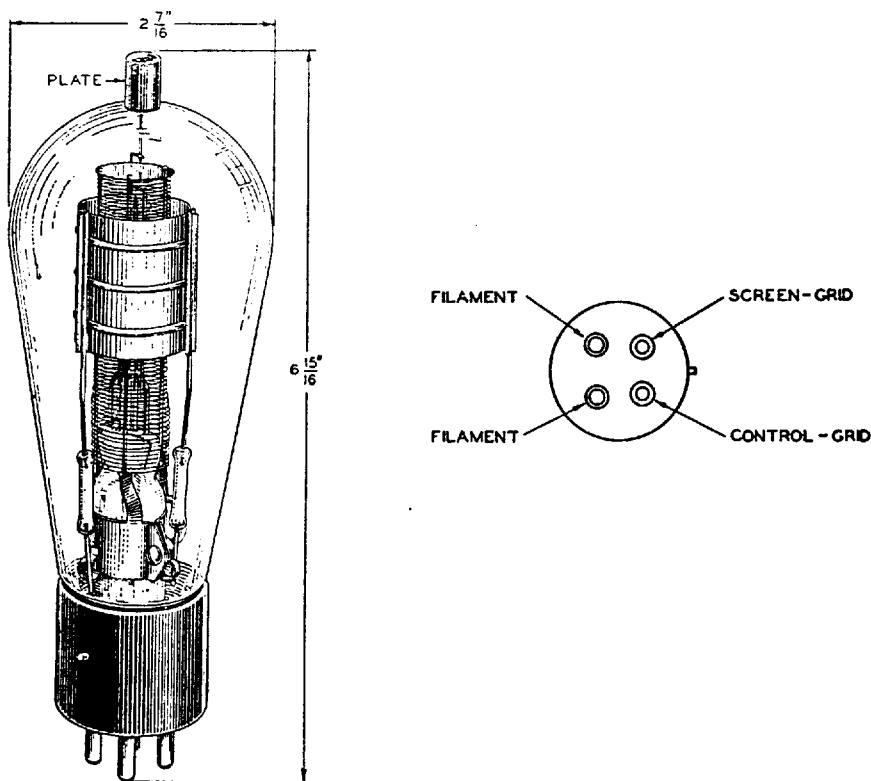

Classification

The No. 254B Vacuum Tube is a four-element, screen-grid tube for use as a radio-frequency power-amplifier and as a harmonic-generator at intermediate power levels at high frequencies. It may also be used as an oscillator at high frequencies where the reduced plate to control-grid capacity will be of advantage.

Base and Socket

The No. 254B Vacuum Tube employs a standard four-prong, thrust-type base suitable for use in a Western Electric No. 130B (rigid) or No. 131A (cushion) Socket or similar type socket. The arrangement of electrode connections to the base terminals is shown above. The anode terminal is located at the top of the bulb and is arranged for a special, quick-release connector.

Rating and Characteristic Data

Filament Voltage.....	7.5 Volts
Filament Current.....	3.25 Amperes
Average Thermionic Emission.....	1.0 Ampere
Maximum Plate Voltage.....	750 Volts
Maximum Plate Current.....	0.075 Ampere
Maximum Plate Dissipation.....	25 Watts
Screen Grid Potential.....	150 Volts
Maximum Screen Grid Dissipation.....	5 Watts
Average Amplification Factor.....	100
Average Plate Resistance.....	75,000 Ohms
Average Mutual Conductance.....	1,330 Micromhos

Approximate Direct Interelectrode Capacities

Plate to Control Grid.....	0.085 MMF
Plate to Filament and Screen Grid.....	5.4 MMF
Control Grid to Filament and Screen Grid.....	11.2 MMF

Average Static Characteristics

The accompanying curves give the average static characteristics of the No. 254B Vacuum Tube. These curves are taken with the filament operating on alternating current with the plate, screen and control grid circuit returns connected to a midpoint of the filament transformer.

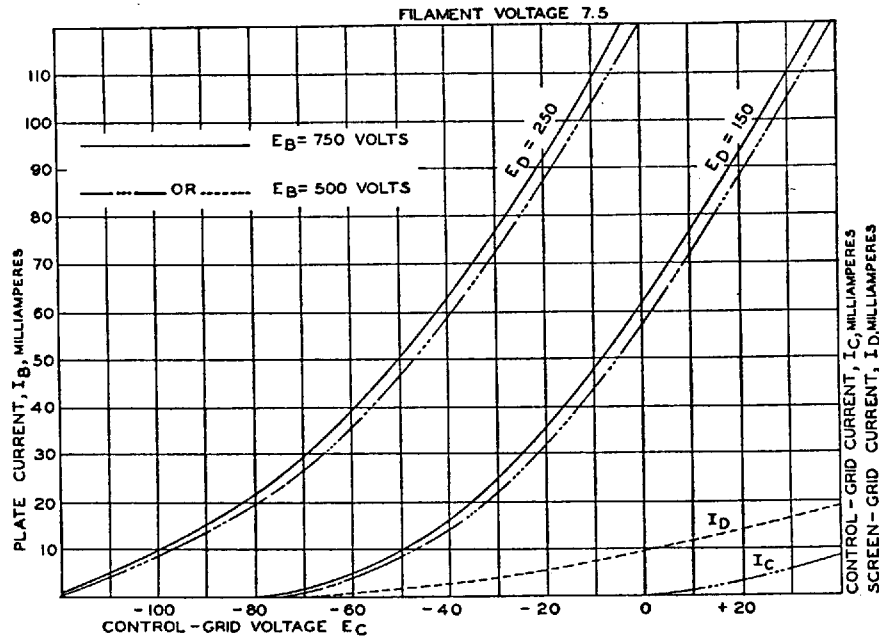

General Features

The No. 254B Vacuum Tube employs an extra grid or screen which provides an electrostatic shield between the plate and control grid. Such internal shielding eliminates the necessity of neutralization to prevent unwanted oscillations or feedback if the rest of the circuit elements are properly shielded. The screen has been designed to reduce secondary emission to a minimum.

The thoriated tungsten filament of this tube is made in a spiral of such form as to maintain the tube internal impedance low and constant during its life. The mechanical structure has adequate strength for severe usages.

256A Vacuum Tube

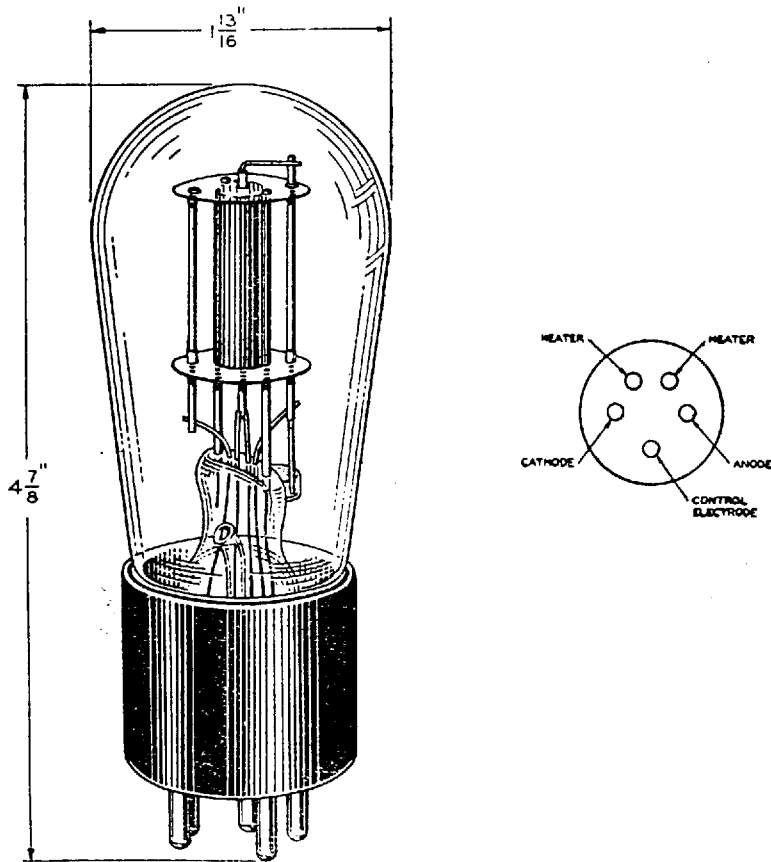

Classification

The No. 256A Vacuum Tube is a three-element tube which employs an indirectly heated cathode and contains argon gas at a low pressure. It is intended for use in special circuits as a relay or trigger-action device.

Base and Socket

The No. 256A Vacuum Tube employs a standard five-prong, thrust-type base suitable for use in a Western Electric 137A or similar type socket. The arrangement of electrode connections to the base terminals is shown above.

Rating and Characteristic Data

Heater Voltage.....	2.3 Volts AC
Nominal Heater Current.....	1.7 Amperes
Anode-Cathode Potential Drop when Conducting.....	10-20 Volts
Maximum Instantaneous Space Current.....	75 Milliamperes
Maximum Instantaneous Potential between Anode and Control-Electrode.....	325 Volts
Maximum Potential between Cathode and Heater.....	12 Volts

Average Static Characteristics

The accompanying curves give the average static characteristics of the No. 259A Vacuum Tube.

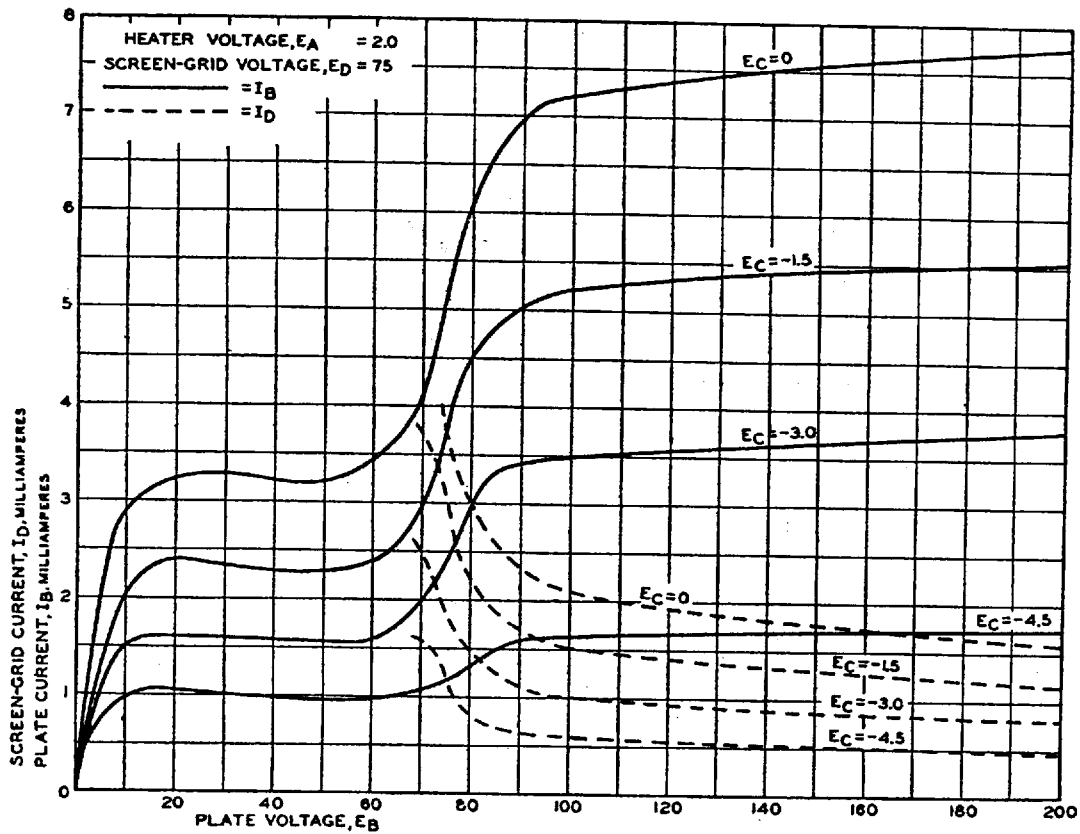

General Features

The No. 259A Vacuum Tube employs an extra grid or a screen which provides an electrostatic shield between the plate and control grid. Such internal shielding eliminates the necessity of neutralization to prevent unwarranted oscillation or feed-back if the rest of the circuit elements are properly shielded.

The structure has been so designed as to give an unusually high mutual conductance for a tube of its rating, thereby making possible a comparatively high amplification.

The cathode is designed to provide a very large electron emission compared with the space current drain, thus assuring the maintenance of uniform electrical characteristics over a long life.

262A Vacuum Tube

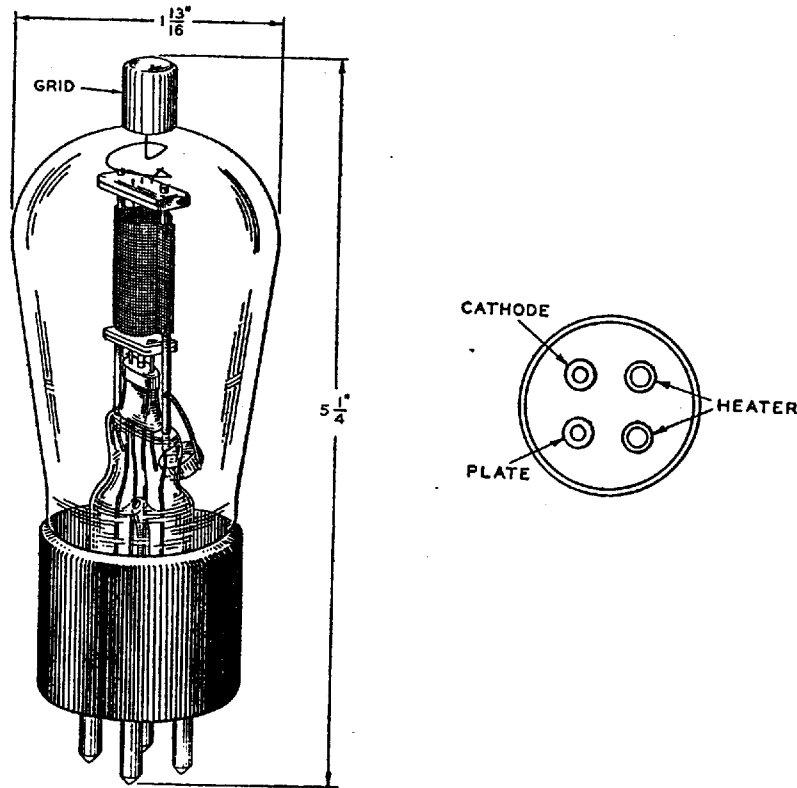

Classification

The No. 262A Vacuum Tube is a general purpose tube having an indirectly heated cathode designed to permit operation of the heater element directly on alternating current. The tube is for use as an audio-frequency amplifier in high gain circuits.

Base and Socket

The No. 262A Vacuum Tube employs a standard four-prong base suitable for use in a Western Electric No. 130B (rigid) or No. 131A (cushion) socket or similar type socket. The arrangement of the electrode connections to the base terminals is shown above. The grid terminal is located at the top of the bulb.

Rating and Characteristic Data

Heater Voltage.....	10 Volts, AC or DC
Average Heater Current.....	0.32 Amperes
Plate Voltage.....	135 180 Volts Maximum
Grid Voltage.....	-6.0 -7.5 Volts
Average Plate Current.....	1.6 2.8 Milliampères
Average Plate Resistance.....	21,200 17,500 Ohms
Average Amplification Factor.....	14.7 14.9

Approximate Direct Interelectrode Capacities

Plate to Grid.....	1.9 MMF
Plate to Cathode.....	4.0 MMF
Grid to Cathode.....	1.8 MMF

Average Static Characteristics

The accompanying curves give the average static characteristics of the No. 262A Vacuum Tube.

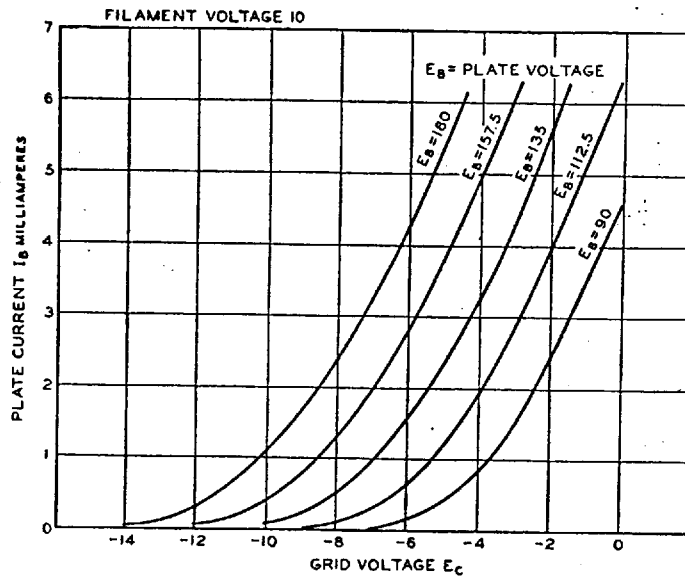

General Features

The No. 262A Vacuum Tube is designed with electrical characteristics particularly suitable for use in intermediate stages of audio-frequency amplifiers where either resistance or transformer coupling is used.

By special features in design and by careful control of the manufacturing processes the disturbing hum output due to the use of alternating current in the heater is maintained at an extremely low level. This makes the tube especially suitable, when alternating current filament supply is used, for the early stages of high gain audio-frequency amplifiers where the use of ordinary heater type tubes would be entirely impracticable.

The rigid and non-resonating structure of this tube makes it unusually non-microphonic. Its microphonic response to a given mechanical stimulus is from 10 to 20 db below that of heater tubes of conventional design.

264A Vacuum Tube

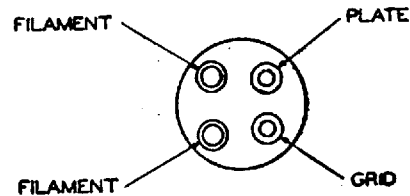
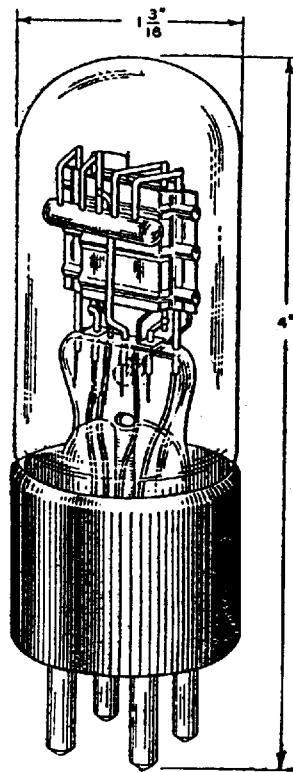

Classification

The No. 264A Vacuum Tube is a three-element filament type tube for use as an audio-frequency amplifier in applications requiring a tube with low microphonic noise response or in apparatus where high input resistance is necessary.

Base and Socket

The No. 264A Vacuum Tube employs a standard four-prong thrust-type base suitable for use in a Western Electric No. 130B (rigid) or No. 131A (cushion) socket or similar type socket. The arrangement of electrode connections to the base terminals is shown above.

Rating and Characteristic Data

Filament Voltage.....	1.5 Volts, DC
Filament Current.....	0.3 Ampere
Maximum Plate Voltage.....	100 Volts
Grid Voltage.....	-7.0 Volts
Average Plate Current.....	2.6 Milliampere
Average Plate Resistance.....	11,800 Ohms
Average Amplification Factor.....	7.0

Approximate Direct Interelectrode Capacities

Plate to Grid.....	5.3 MMF
Plate to Filament.....	2.2 MMF
Grid to Filament.....	3.5 MMF

Average Static Characteristics

The accompanying curves give the static characteristics of the No. 264A Vacuum Tube. These curves have been obtained with the filament operating on direct current and the grid and plate returns connected to the negative filament terminal.

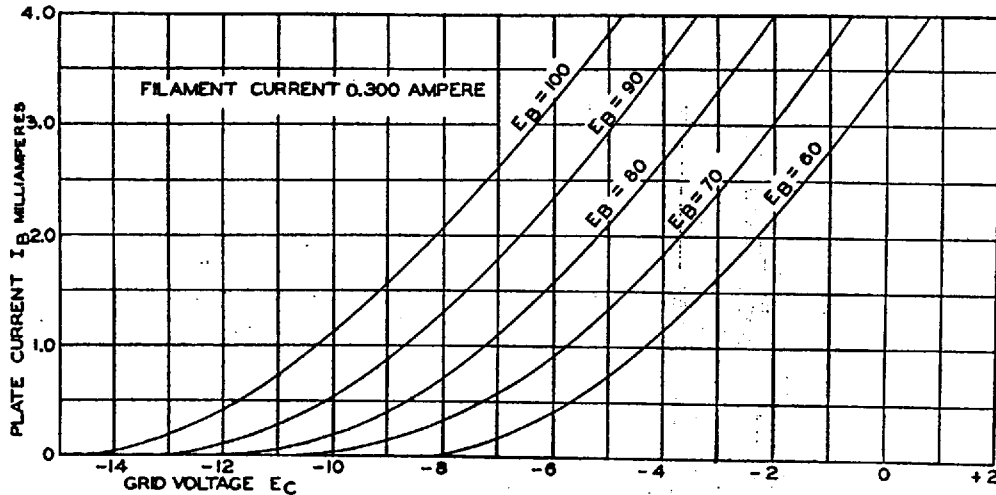

General Features

Due to the rigid construction and the short filament which has been designed to reduce vibration to a minimum, the microphonic response of the No. 264A Vacuum Tube is very low.

Care in manufacture and also inspection tests insure a high input resistance.

These features together with its low power consumption make this tube particularly suitable for use in the early stages of high gain amplifiers.

The rugged construction of the tube and ample electron emission supplied by the filament operating at a low temperature, insure the maintenance of uniform electrical characteristics throughout a long life.

271A Vacuum Tube

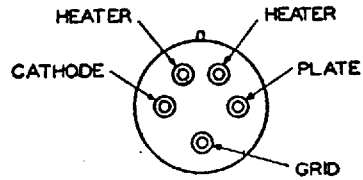
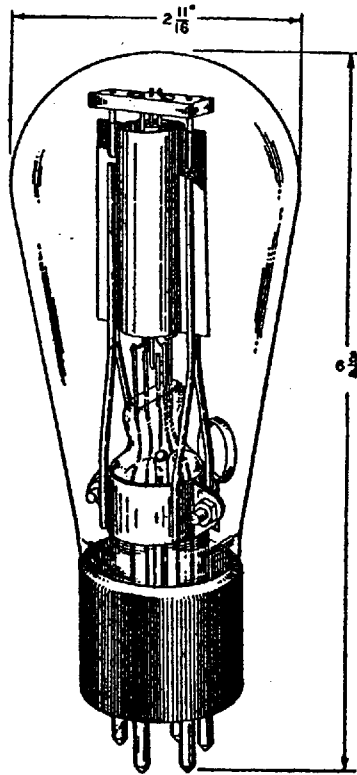

Classification

The No. 271A Vacuum Tube is a general purpose three-element tube having an indirectly heated cathode which permits operation directly on alternating current. The tube is for use as an audio-frequency amplifier in output stages. It may also be used as a radio-frequency amplifier and, under restricted conditions, as an oscillator or modulator.

Base and Socket

The No. 271A Vacuum Tube employs a standard five-prong base suitable for use in a Western Electric No. 134A (cushion) or No. 137A (rigid) socket or similar type socket. The arrangement of electrode connections to the base terminals is shown above.

Rating and Characteristic Data

Heater Voltage.....		5 Volts, AC or DC
Average Heater Current.....		2 Amperes
Plate Voltage.....	350	400 Volts Maximum
Grid Voltage.....	-25	-30 Volts
Average Plate Current.....	36	39 Milliamperes
Average Plate Resistance.....	2900	2850 Ohms
Average Amplification Factor.....	8.5	8.5

Approximate Direct Interelectrode Capacities

Plate to Grid.....	5.3 MMF
Plate to Cathode.....	3.8 MMF
Grid to Cathode.....	6.5 MMF

Average Static Characteristics

The accompanying curves give the average static characteristics of the No. 271A Vacuum Tube.

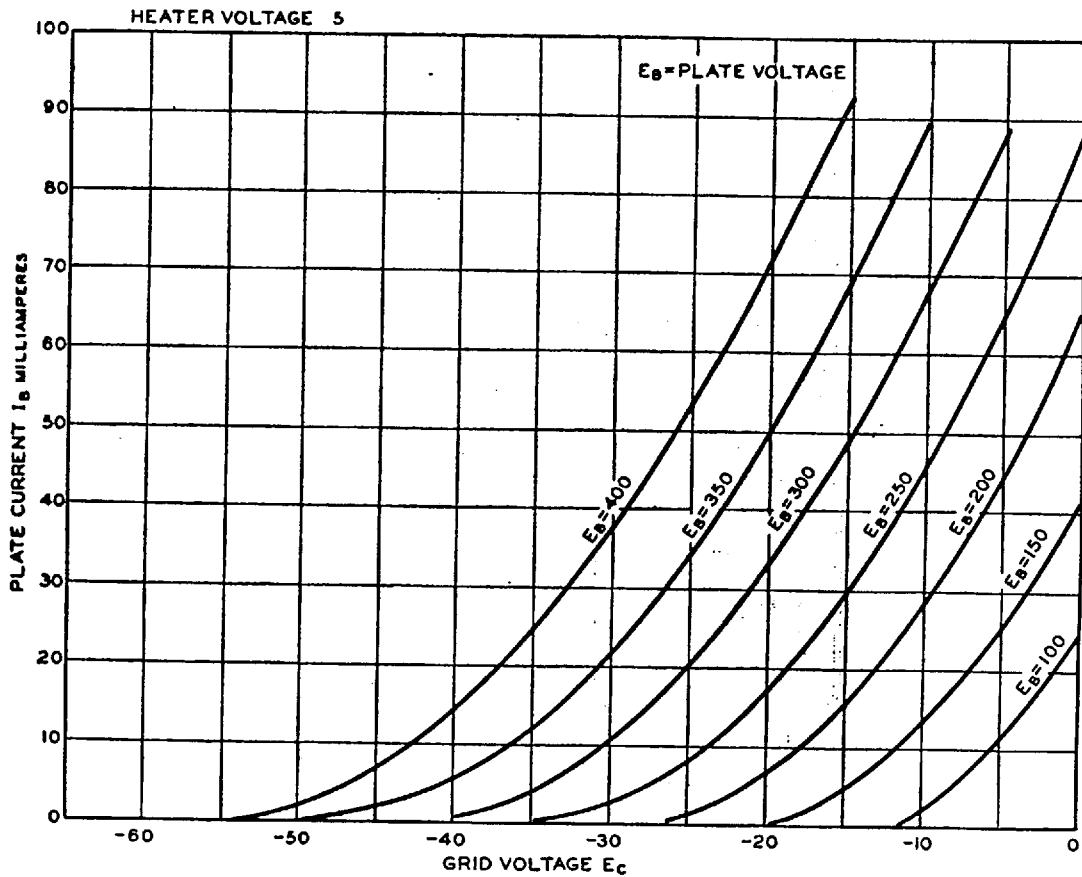

General Features

The indirectly heated cathode of the No. 271A Vacuum Tube makes it suitable for use as a power amplifier in applications requiring a low hum disturbance resulting from the use of alternating current for cathode power supply. Its hum level is approximately 30 db lower than that of filamentary type tubes of corresponding power output.

It has a large cathode area giving ample electron emission. This, together with the rugged construction, insures the maintenance of uniform electrical characteristics over a long life even when the tube is operated at its maximum rating.

272A Vacuum Tube

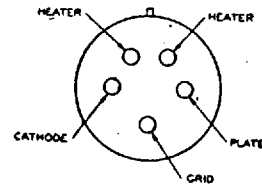
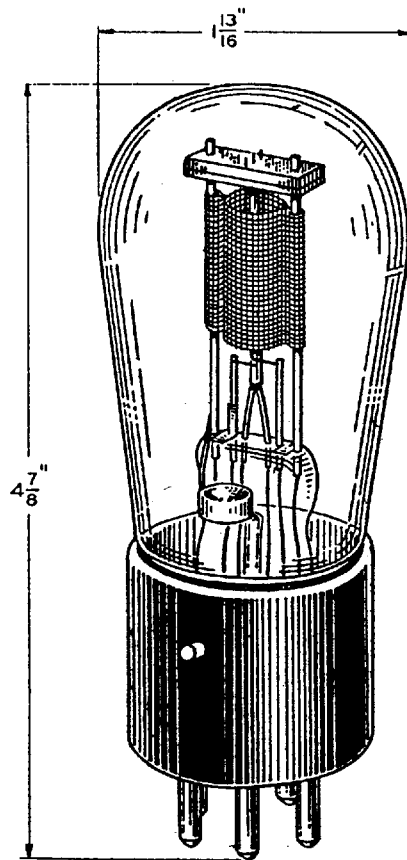

Classification

The No. 272A is a general purpose Vacuum Tube having an indirectly heated cathode which permits operation of the heater element directly on alternating current. It is suitable for use as a detector or power amplifier tube in applications requiring small values of output power.

Base and Socket

The No. 272A Vacuum Tube employs a standard five-prong base suitable for use in a Western Electric No. 134A (cushion), No. 137A (rigid), or similar type socket. The arrangement of electrode connections to the base terminals is shown above.

Rating and Characteristic Data

Heater Voltage.....	10 Volts, AC or DC
Average Heater Current.....	0.32 Ampere
Plate Voltage.....	140 180 Volts Max.
Grid Voltage.....	-15 -21
Average Plate Current.....	5.4 5.9 Milliampere
Average Plate Resistance.....	7,200 7,200 Ohms
Average Amplification Factor.....	5.6 5.5

Approximate Direct Interelectrode Capacities

Plate to Grid.....	2.8 MMF
Plate to Cathode.....	2.6 MMF
Grid to Cathode.....	3.4 MMF

Average Static Characteristics

The accompanying curves give the average static characteristics of the No. 272A Vacuum Tube.

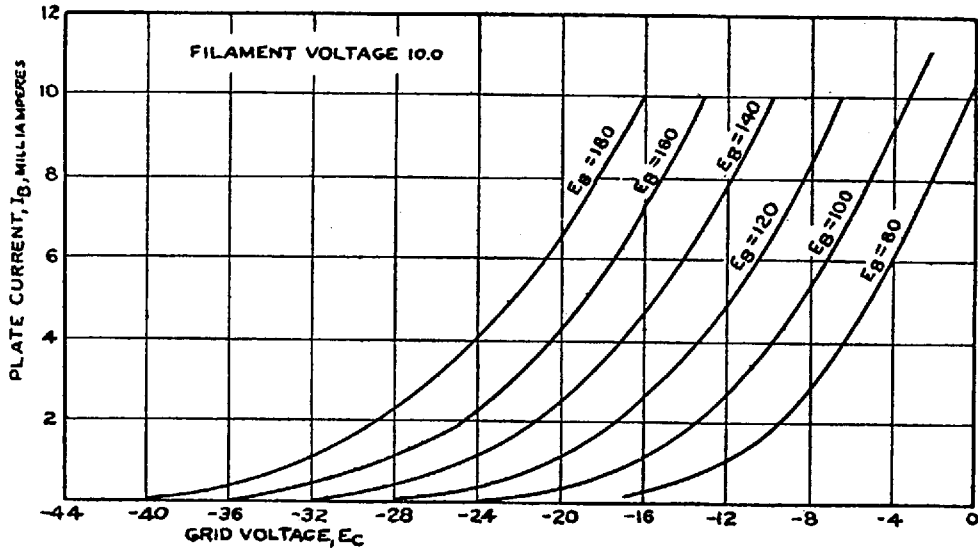

General Features

The No. 272A Vacuum Tube is adaptable to applications in which it is desirable to have a tube of the heater cathode type with low heater current consumption.

It is suitable for use in the final stages of amplifiers requiring somewhat greater output power than that given by the No. 262A Vacuum Tube.

274A Vacuum Tube

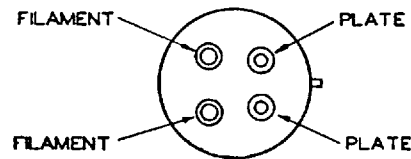
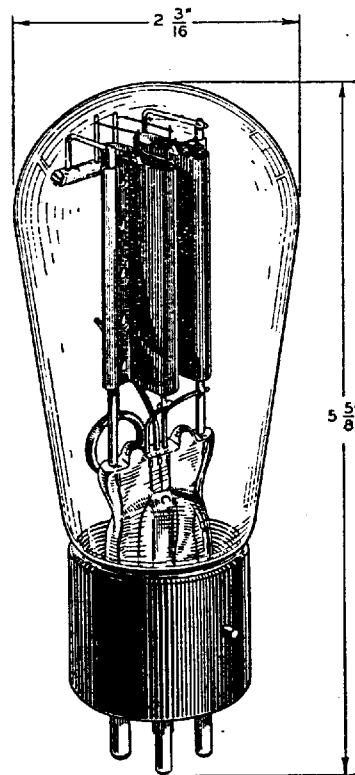

Classification

The No. 274A Vacuum Tube is a full-wave, thermionic, high-vacuum rectifier for use in circuits designed to supply direct current from an alternating current supply.

Base and Socket

The No. 274A Vacuum Tube employs a four-prong base suitable for use in a Western Electric No. 130B Socket or similar type socket. The arrangement of electrode connections to the base terminals is shown above.

Rating and Characteristic Data

Filament Voltage.....		5.0 Volts
Filament Current.....		2.0 Amperes
	Choke Input Filter	Condenser Input Filter
Maximum A.C. Voltage per Plate.....	660 Volts R.M.S.	450 Volts R.M.S.
Maximum Total Rectified Current	150 Milliamperes	130 Milliamperes

Average Static Characteristics

The accompanying curves gives the average static characteristics of the No. 274A Vacuum Tube. The current for a single plate is given as a function of the voltage applied between the plate and the center taps of the filament transformer.

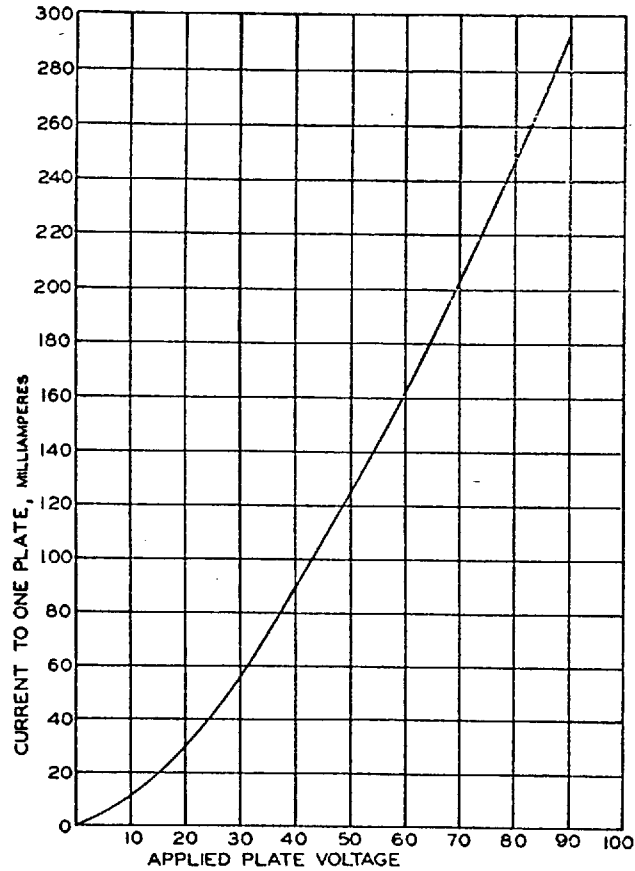

General Features

The No. 274A high vacuum rectifier tube is particularly adapted for use in applications where it is impracticable to place any limitations on the ambient temperatures and where it is necessary to apply the plate voltage simultaneously with the filament voltage.

Its large plate area results in a relatively low potential drop between the plate and filament. This makes possible better voltage regulation than is usually obtained with high vacuum thermionic rectifiers.

The large filament area gives ample electron emission to insure uniform electrical characteristics over a long life and satisfactory operation even under very severe service conditions.

275A Vacuum Tube

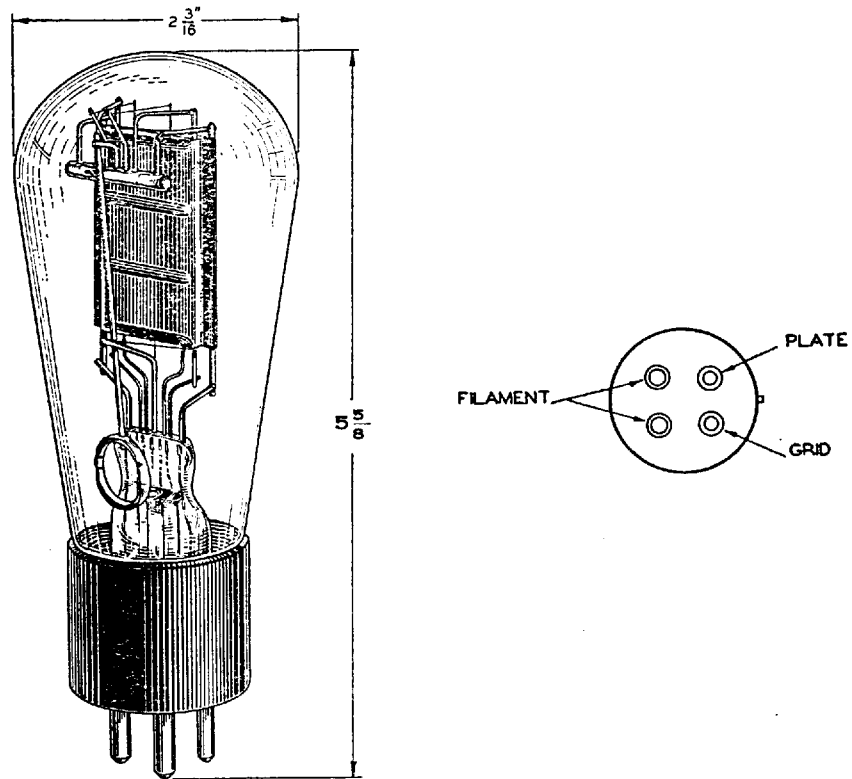

Classification

The No. 275A Vacuum Tube is a three-element filament type tube for use as a low-voltage power tube for output stages in audio-frequency amplifiers.

Base and Socket

The No. 275A Vacuum Tube employs a standard four-prong, thrust-type base suitable for use in a Western Electric No. 130B (rigid) or No. 131A (cushion) Socket or similar type socket. The arrangement of electrode connections to the base terminals is shown above.

Rating and Characteristic Data

Filament Voltage.....		5 Volts, AC or DC
Average Filament Current.....		1.2 Amperes
Plate Voltage.....	200	250 Volts Maximum
Grid Voltage.....	-45	-60 Volts
Average Plate Current.....	45	52 Milliampères
Average Plate Resistance.....	1,000	1,000 Ohms
Average Amplification Factor.....	2.9	2.85

Approximate Direct Interelectrode Capacities

Plate to Grid.....	12 MMF
Plate to Filament.....	3.2 MMF
Grid to Filament.....	6.8 MMF

Average Static Characteristics

The accompanying curves give the average static characteristics of the No. 275A Vacuum Tube.

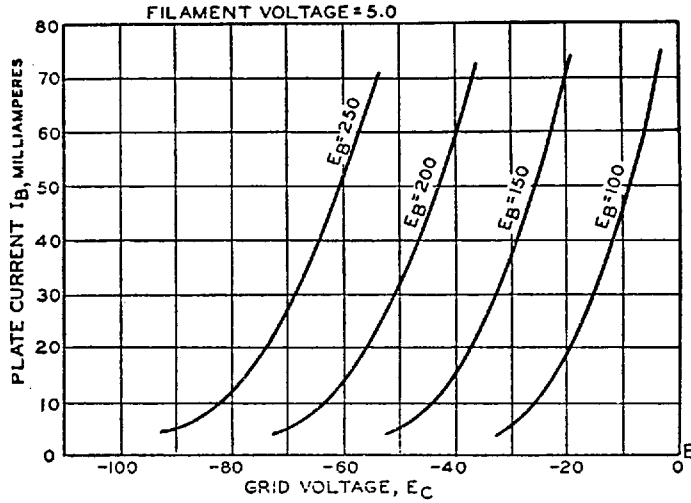

General Features

The electrical characteristics of the No. 275A Vacuum Tube make it particularly adaptable in applications requiring an output power tube operated at relatively low plate voltage.

It has an unusually large plate area for its energy dissipation. The total electron emission of the filament is large compared to the maximum space current drain. Both factors insure the delivery of full output power throughout a long life.

The rugged structure insures against breakage in shipment and in service and makes possible the maintenance of uniform electrical characteristics.

276A Vacuum Tube

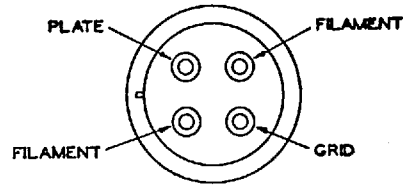
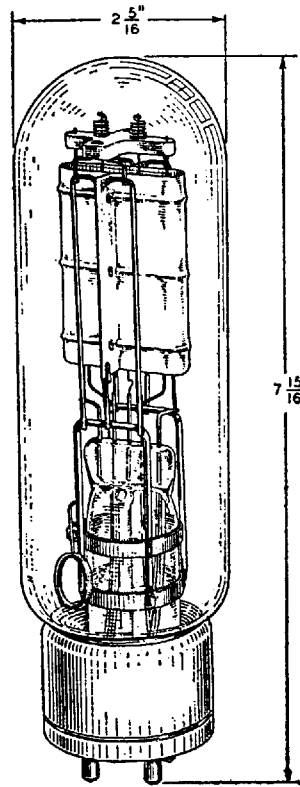

Classification

The No. 276A Vacuum Tube is a three-element tube used as an oscillator, radio-frequency amplifier, modulator or audio-frequency amplifier.

Base and Socket

The No. 276A Vacuum Tube employs a standard four-prong bayonet pin type base suitable for use in a Western Electric No. 112A or similar type socket. The arrangement of electrode connections to the base terminals is shown above.

General Ratings and Information

Filament Voltage.....	10 Volts, AC
Nominal Filament Current.....	3 Amperes
Maximum Plate Voltage.....	1,250 Volts
Maximum Plate Current.....	0.125 Ampere
Average Plate Resistance.....	3,500 Ohms
Average Amplification Factor.....	12

Approximate Direct Interelectrode Capacities

Plate to Grid.....	9 MMF
Plate to Filament.....	4 MMF
Grid to Filament.....	6 MMF

Audio-Amplifier or Modulator Rating—Peak Grid Drive equal to or less than the bias—Class A Service.

Maximum Plate Voltage.....	1,000
Maximum Plate Current.....	0.85 Ampere
Maximum Plate Dissipation.....	85 Watts
Grid Bias Voltage.....	—50 Volts
Load Impedance.....	7,000 Ohms
Undistorted Output.....	10 Watts

Radio-Frequency Amplifier—Grid Bias practically at cut-off, grid drive higher than the bias—Class B Service.

Maximum Plate Voltage.....	1,250
Maximum Plate Current.....	0.125 Ampere
Maximum Plate Dissipation.....	100 Watts
Grid Bias Voltage.....	—100 Volts
Peak Output.....	100 Watts

Oscillator or Radio-Frequency Amplifier—Grid Bias below Cut-Off—Class C Service.

Maximum Modulated Plate Voltage (DC).....	1,000 Volts
Maximum Non-modulated Plate Voltage (DC).....	1,250 Volts
Maximum Plate Current.....	0.125 Ampere
Maximum Plate Dissipation.....	100 Watts
Maximum Radio-Frequency Charging Current in Grid and Plate Leads	5 Amperes
Approximate Grid Bias.....	—150 Volts
Maximum Output.....	100 Watts

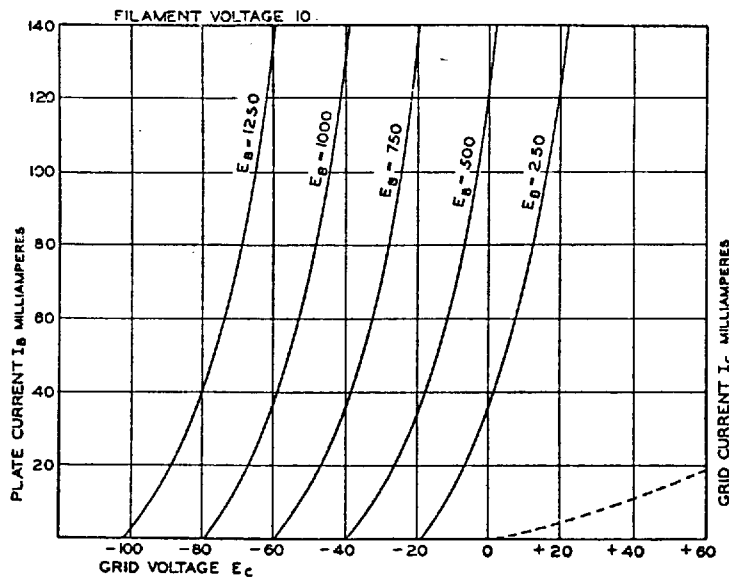

Average Static Characteristics

The accompanying curves give the average static characteristics of the No. 276A Vacuum Tube. These curves are taken with the filament operating on alternating current and with the plate and grid returns connected to a center point on the filament transformer.

General Features

The electrical characteristics of the No. 276A Vacuum Tube are substantially the same as the No. 242A Vacuum Tube except for interelectrode capacities and filament resistance. In the design of the No. 276A Vacuum Tube, special attention has been given to obtain low interelectrode capacities. This permits of satisfactory operation over a wide frequency range. With a filament potential drop of 10 volts, the filament current range of the No. 276A Vacuum Tube is 2.8 to 3.2 amperes while for the No. 242A Vacuum Tube, the filament current range is 3.0 to 3.4 amperes. Thoriated tungsten is used for the filament in both tubes.

This Vacuum Tube has an unusually rugged type of structure which insures it against breakage in shipment and service and makes possible the maintenance of uniform electrical characteristics.

277A Vacuum Tube

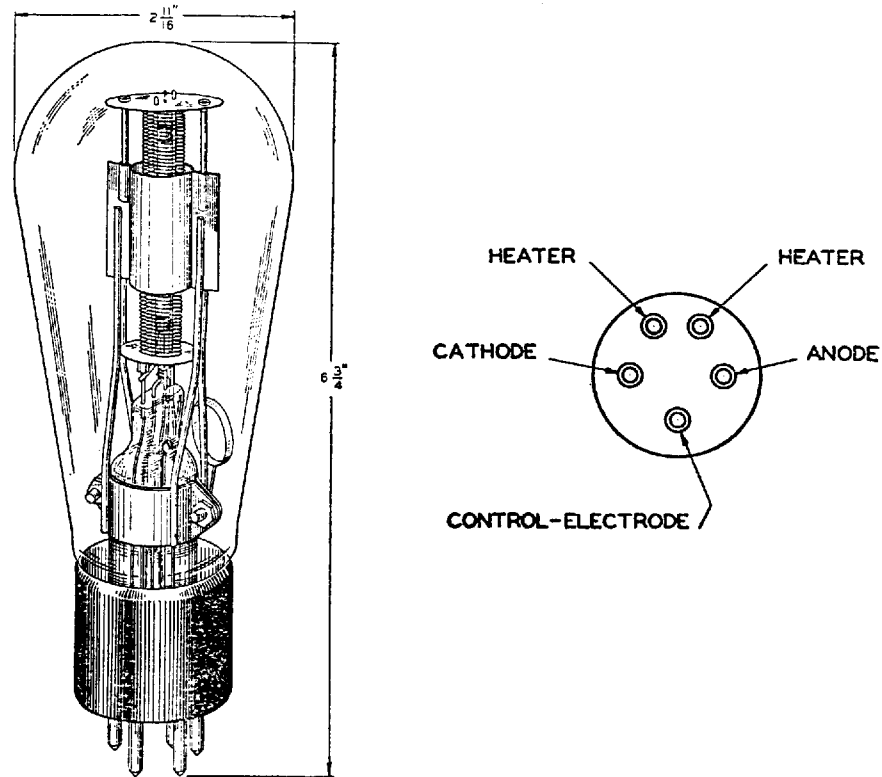

Classification

The No. 277A Vacuum Tube is a three-element tube which employs an indirectly heated cathode and contains argon gas at a low pressure. It is intended for use in special circuits as a relay or trigger-action device.

Base and Socket

The No. 277A Vacuum Tube employs a standard five-prong, thrust-type base suitable for use in a Western Electric No. 137A Socket or similar type socket. The arrangement of electrode connections to the base terminals is shown above.

Rating and Characteristic Data

Heater Voltage	5 Volts, AC
Nominal Heater Current	2 Amperes
Anode-Cathode Potential Drop when Conducting	10 to 20 Volts
Maximum Instantaneous Space Current	500 Milliamperes
Maximum Instantaneous Potential between Anode and Control-Electrode	350 Volts
Maximum Potential between Cathode and Heater	12 Volts

Breakdown Characteristics

A typical curve relating the critical control-electrode potential to the anode potential is given in the accompanying chart. This characteristic may vary from tube to tube and during the life of a given tube.

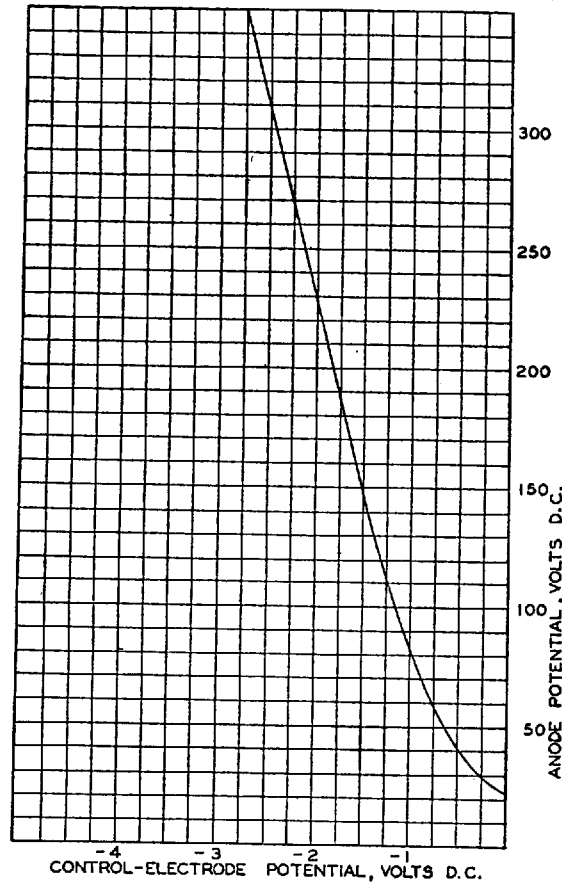

General Features

The No. 277A Vacuum Tube is primarily a rectifier of low internal impedance whose conduction cycle is determined by the relative instantaneous control-electrode and anode potentials. The special treatment of electrode elements and the use of argon gas whose pressure remains practically constant over wide temperature ranges are outstanding design features. The above qualities insure uniform and reproducible characteristics essential to various circuit applications such as: controlled frequency oscillators giving a square wave form, peak voltmeters or volume level-indicators, photoelectric cell control and recording equipments, and variable voltage rectifiers.

280A Vacuum Tube

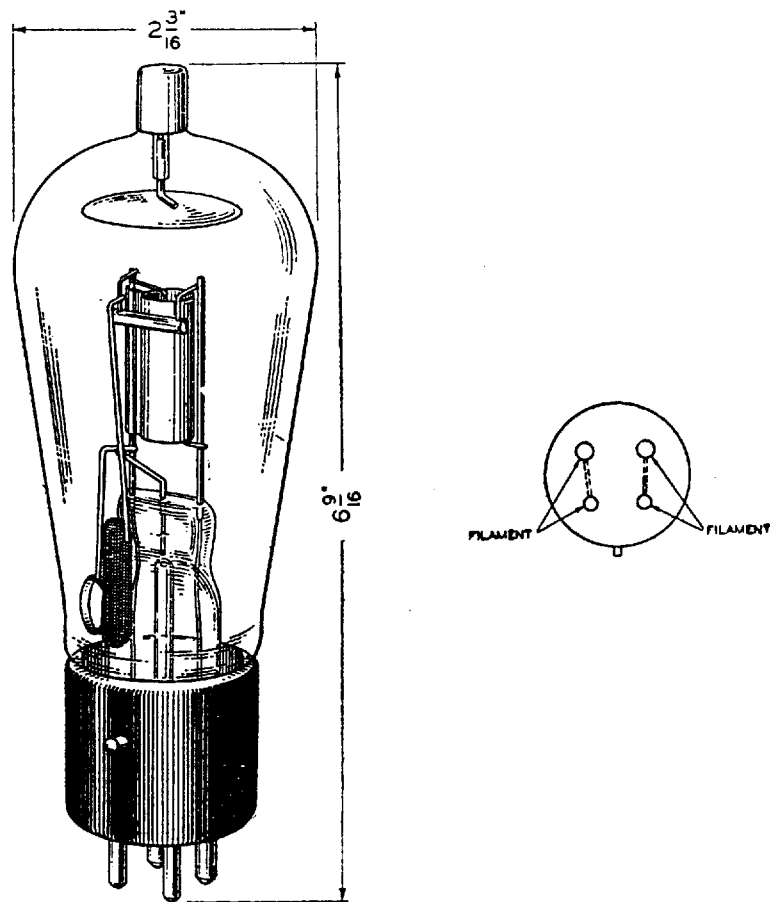

Classification

The No. 280A Vacuum Tube is a half-wave, thermionic, mercury-vapor rectifier for use in rectifying circuits designed to supply direct current from an alternating current supply.

Base and Socket

The No. 280A Vacuum Tube employs a standard four-prong thrust-type base suitable for use in the Western Electric No. 130B or similar type socket. It is to be noted from the arrangement of electrode terminals shown above that the filament terminals are tied together in parallel. The corresponding socket terminals should also be connected to insure the best contact conditions for the filament current. The anode terminal is located at the top of the bulb and is arranged for a special quick release connector. The tube can only be mounted in a vertical position with the base end down.

Rating and Characteristic Data

Filament Voltage.....	2.5 Volts
Nominal Filament Current.....	3 Amperes
Approximate Anode-Cathode Potential Drop when Conducting.....	15 Volts
Maximum Peak Plate Current.....	0.5 Ampere
Maximum Peak Inverse Potential.....	3,500 Volts
Safe Operating Ambient Temperature.....	10 to 50 Degrees C.

The anode-cathode potential drop is substantially independent of the plate current. The exact value varies from tube to tube and during the life of a given tube. Within the specified ambient temperature range and plate current range it will vary from 5 to 25 volts.

Typical Rectifying Circuits

For specific circuits the following ratings apply:

Type of Circuit	Number of Tubes	Load Potential Volts	Load Current Amperes
Single-Phase, Half-Wave.....	1	1,000	0.15
Single-Phase, Double Half-Wave.....	2	1,000	0.30
Single-Phase, Double Half-Wave (Four Tube Series Circuit).....	4	2,000	0.30
Three-Phase (Six Tube Series "Y" Circuit).....	6	3,000	0.45

General Features

The mercury vapor type of rectifying tube has the desirable property of a low and almost constant potential drop between the cathode and anode when the tube is passing current. Due to their low potential drop a much more efficient rectifier system can be had than is possible by the use of high vacuum rectifier tubes, whose potential drop are relatively high. The constancy of the potential drop with space current makes possible rectifying systems whose regulation depends almost entirely on the regulation of the plate transformers.

The No. 280A Vacuum Tube employs a highly efficient oxide-coated type of cathode. Its mechanical construction is such that the active materials are maintained for long operating periods as well as during shelf life and shipment.

282A Vacuum Tube

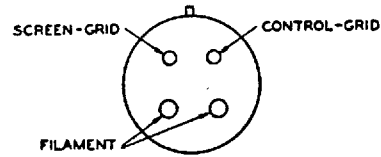
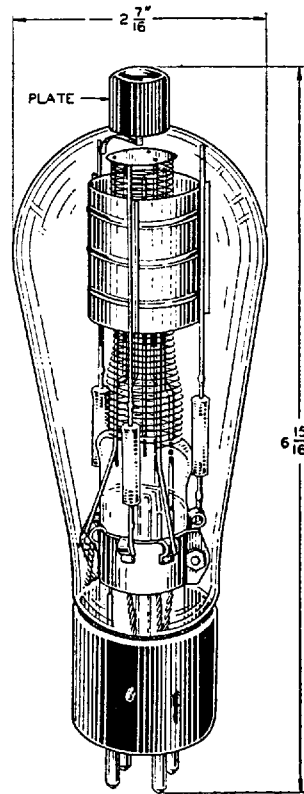

Classification

The No. 282A Vacuum Tube is a four-element, screen-grid tube for use as a radio-frequency power amplifier or a harmonic-generator at intermediate power levels at high frequencies. It may also be used as an oscillator at high frequencies where the reduced plate to control-grid capacity will be of advantage.

Base and Socket

The No. 282A Vacuum Tube employs a standard four-prong thrust type base suitable for use in a Western Electric 130B (rigid), 131A (cushion), or similar type socket. The arrangement of electrode connections to the base terminals is shown above. The plate terminal is located at the top of the bulb and is arranged for a special quick release connector.

Rating and Characteristic Data

Filament Voltage.....	10 Volts
Nominal Filament Current.....	3 Amperes
Average Thermionic Emission.....	1.25 Amperes
Maximum Plate Voltage, DC.....	1000 Volts
Maximum Plate Current, DC.....	0.100 Ampere
Maximum Plate Dissipation.....	70 Watts
Maximum Screen-Grid Potential.....	250 Volts
Maximum Screen-Grid Dissipation.....	5 Watts
Average Amplification Factor.....	100
Average Plate Resistance.....	70,000 Ohms
Average Mutual Conductance.....	1430 Micromhos

Approximate Direct Interelectrode Capacities

Plate to Control-Grid.....	0.2 MMF
Plate to Filament and Screen-Grid.....	6.8 MMF
Control-Grid to Filament and Screen-Grid.....	12.2 MMF

Average Static Characteristics

The accompanying curves give the average static characteristics of the No. 282A Vacuum Tube. These curves are taken with the filament operated on alternating current and with the plate, screen and control-grid circuit returns connected to a mid-point of the filament transformer.

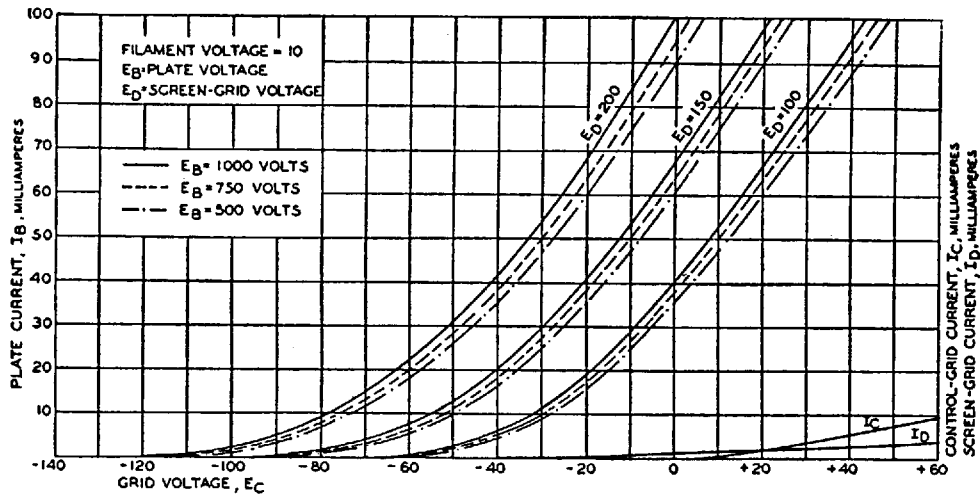

General Features

The No. 282A Vacuum Tube employs an extra grid or screen which provides an electrostatic shield between the plate and control-grid. Such internal shielding eliminates the necessity of neutralization to prevent unwanted oscillations or feed-back if the rest of the circuit elements are properly shielded. The screen has been designed to reduce the amount of current collected by it. The No. 282A bulb is made of hard glass which allows it to operate at higher temperatures and plate dissipation than the 254 type tubes.

The thoriated tungsten filament of this tube is made in a spiral of such form as to maintain the tube internal impedance low and constant during its life. The mechanical structure has adequate strength for severe usage.

284A Vacuum Tube

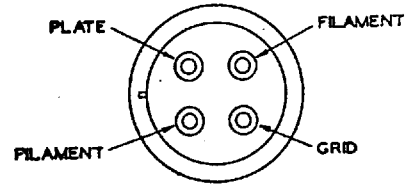
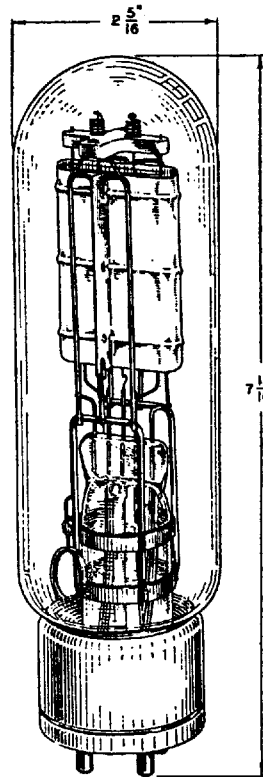

Classification

The No. 284A Vacuum Tube is a 3 element tube for use as an audio-frequency amplifier, modulator, oscillator, or radio-frequency amplifier.

Base and Socket

The No. 284A Vacuum Tube employs a standard four prong bayonet pin type base suitable for use in a Western Electric 112A or similar type socket. The arrangement of electrode connections to the base terminals is shown above.

General Ratings and Information

Filament Voltage.....	10 Volts AC.
Nominal Filament Current.....	3.25 Amperes
Maximum Plate Voltage.....	1250 Volts
Maximum Plate Current.....	0.150 Ampere
Average Plate Resistance.....	1900 Ohms
Average Amplification Factor.....	4.7
Approximate Direct Interelectrode Capacities	
Plate to Grid.....	8.2 MMF
Plate to Filament.....	7.8 MMF
Grid to Filament.....	7.0 MMF
Audio Amplifier or Modulator Rating—Peak Grid Drive equal to or less than the bias—Class A Service.	
Maximum Plate Voltage.....	1000
Maximum Plate Current.....	0.85 Ampere
Maximum Plate Dissipation.....	85 Watts
Grid Bias Voltage.....	—165

Typical outputs obtainable within recommended operating conditions for different resistance loads, R, and for inputs on the grid equal to the grid bias:

Plate Volts	Plate Current (Milli-amperes)	Approx. Grid Volts	Approx. Plate Resistance, R_p (Ohms)	R, Load Resistance	Fundamental Power Output (Watts)	Second Harmonic % of Funda.	Third Harmonic % of Funda.
750	100	-106	1600	$R = 2R_p$	16.6	4.5	.8
				$R = 5R_p$	10.5	1.1	.03
750	75	-116	1760	$R = 2R_p$	16.9	7.5	2.0
				$R = 5R_p$	10.8	2.0	.16
1000	85	-165	1700	$R = 2R_p$	33.3	10.0	3.2
				$R = 5R_p$	22.5	2.4	.4
1000	50	-178	2100	$R = 5R_p$	20.6	5.0	1.8
				$R = 2R_p$	52.5	15.8	5.6
1250	60	-228	2000	$R = 2R_p$	52.5	15.8	5.6
				$R = 5R_p$	41.5	5.1	2.2
1250	40	-238	2440	$R = 5R_p$	31.3	7.0	2.8

It is possible to obtain very substantial reduction in 2nd harmonic output by the use of the push-pull circuit. With resistance loads greater than twice the plate resistance of the tube, improved levels of harmonic outputs are obtained with relatively little sacrifice in the level of the fundamental power outputs.

Radio Frequency, Oscillator, or Amplifier—Grid Bias practically at or greater than cut-off, grid drive higher than the bias—Class B or C Service.

Maximum Plate Voltage.....	1250
Maximum Plate Current.....	0.150 Ampere
Maximum Plate Dissipation.....	100 Watts
Grid Bias Voltage.....	-300 Volts
Maximum R.F. Charging Current in Grid or Plate Leads.....	5 Amperes
Peak Output.....	100 Watts

Average Static Characteristics

The accompanying curves give the average static characteristics of the No. 284A Vacuum Tube. These curves are taken with the filament operating on alternating current and with the plate and grid returns connected to a center point on the filament transformer.

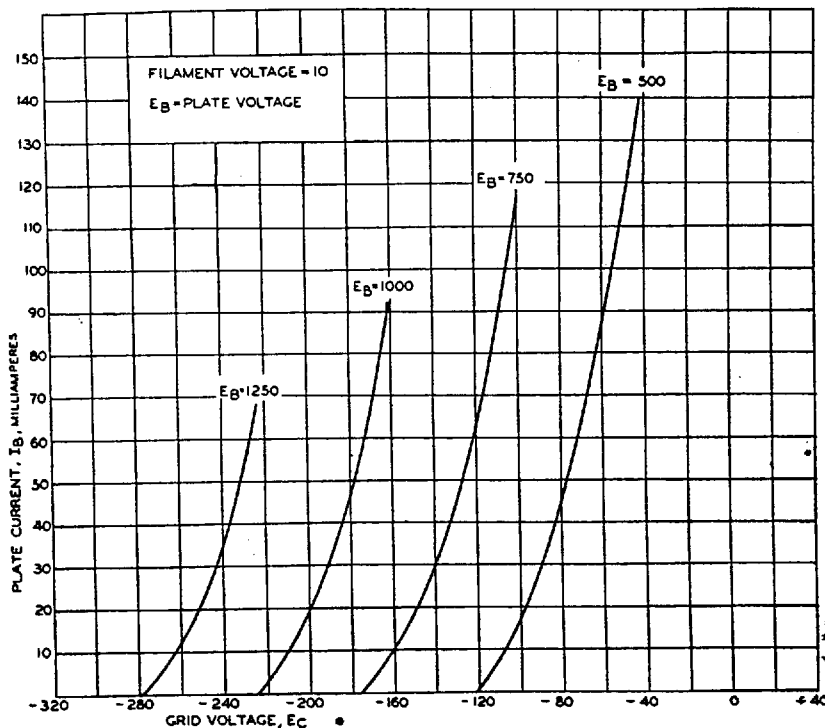

General Features

The electrical characteristics of the No. 284A Vacuum Tube make it especially suitable for audio-frequency power amplifier or modulator. In the design of the No. 284A Vacuum Tube, special attention has been given to obtain low interelectrode capacities, low plate resistance and uniform heating of the plate. Thoriated tungsten is used for the filament.

This vacuum tube has an unusually rugged type of structure which insures it against breakage in shipment and service and makes possible the maintenance of uniform electrical characteristics.

DISTRIBUTOR IN THE UNITED STATES

Graybar

ELECTRIC COMPANY

Akron
Albany
Asheville
Atlanta
Baltimore
Beaumont
Birmingham
Boston
Brooklyn
Buffalo
Charlotte
Chicago
Cincinnati
Cleveland
Columbus

Dallas
Davenport
Dayton
Denver
Detroit
Duluth
Durham
Flint
Fort Wayne
Fort Worth
Grand Rapids
Hammond
Harrisburg
Hartford
Houston

Indianapolis
Jacksonville
Kansas City
Knoxville
Los Angeles
Louisville
Memphis
Miami
Milwaukee
Minneapolis
Mount Vernon
Nashville
Newark
New Haven
New Orleans

New York (2)
Norfolk
Oakland
Oklahoma City
Omaha
Peoria
Philadelphia
Pittsburgh
Portland
Providence
Reading
Richmond
Roanoke
Rochester
St. Louis

St. Paul
Salt Lake City
San Antonio
San Francisco
Savannah
Seattle
Spokane
Syracuse
Tacoma
Tampa
Toledo
Washington
Wichita
Worcester
Youngstown

A NATIONAL ELECTRIC SERVICE

DISTRIBUTOR FOR CANADA AND NEWFOUNDLAND

Northern Electric Company Limited

General Sales Offices: 1620 Notre Dame Street, West, Montreal, P. Q.

Branch Houses

Halifax
Saint John, N. B.
Quebec
Montreal

Ottawa
Toronto
Hamilton
London

Windsor
New Liskeard
Sudbury
Winnipeg

Regina
Calgary
Edmonton
Vancouver

FOREIGN DISTRIBUTORS

International Standard Electric Corporation

67 Broad Street

New York, U. S. A.

Associated, Allied or Affiliated Companies

ARGENTINA

Cla Standard Electric Argentina.
Casilla de Correo 49, (Street Ad-
dress, Paseo Colon 183).
Buenos Aires

AUSTRALIA

Standard Telephones and Cables
(Australasia) Ltd., 71 York Street
(P. O. Box 525-B).
Sydney, N. S. W.

AUSTRIA

United Telephone and Telegraph
Works, Ltd., Dresdner Strasse
No. 75, Vienna, XX/2

BELGIUM

Telephone Manufacturing Co.,
4 Rue Boudewyns. P. O. Box 526,
Antwerp

BRAZIL

International Standard Electric
Corp., Caixa Postal 430, (Street
Address, Rua Visconde de In-
hauma, 64), Rio de Janeiro

CHINA

China Electric Co., Ltd., 230 Med-
hurst Road (P. O. Box 289),
Shanghai

CZECHOSLOVAKIA

Standard Electric Doms a
Spolecnost, Samova, U 1, 664,
Prague

DENMARK

Standard Electric A/S., Jarmers-
gade, 2, Copenhagen, V.

EGYPT

Standard Telephones and Cables.
Ltd., Cozzika Buildings, Sharia
Soliman Pasha, Cairo

FRANCE

Le Materiel Telephonique, 46-47
Quai de Boulogne,
Boulogne-Billancourt (Seine)

GERMANY

Standard Elektrizitäts Gesell-
schaft A/G., Genest Strasse 5,
Berlin-Schöneberg

GREAT BRITAIN

Standard Telephones and Cables.
Ltd., Connaught House, 63 Ald-
wych, London, W. C. 2

HOLLAND

Bell Telephone Manufacturing Co.,
Scheldestraat 169-162,
The Hague

HUNGARY

Standard Electric Co., Ltd.,
Ujpest 4, n. Budapest

INDIA

Standard Telephones and Cables.
Ltd., Block C2, Clive Buildings,
8 Clive Street, Calcutta

ITALY

Standard Elettrica Italiana, Via
Vittoria Colonna No. 9,
Milan, 125

JAPAN

Nippon Electric Co., Ltd., 2 Mita
Shikokumachi, Shiba-Ku, Tokyo

JAVA

Bell Telephone Manufacturing Co.,
Bureau in Nederlandsch Oost In-
die Klouwstraat, 83,
Bandoeng

NEW ZEALAND

Standard Telephones & Cables
(Australasia) Ltd., 24-26 Ballance
Street, P. O. Box 638,
Wellington

NORWAY

Standard Electric Aktieselskap,
Drammensveien, 20,
Oslo

POLAND

Standard Electric Co., W. Polsce,
Sp. Z.O.O. Wspolna 53,
Warsaw

RUMANIA

Standard Electric Romana, S. A.
Strada Bursel 5, Bucharest, 1

SOUTH AFRICA

Standard Telephones and Cables,
Ltd., Exploration Buildings, Com-
missioner and Fox Streets, (P. O.
Box 1571), Johannesburg

SPAIN

Standard Electrica, S/A., Calle de
Ramirez de Prado 3 y 5, (Post
Office Box 7040), Madrid

STRAITS SETTLEMENTS

Standard Telephones and Cables,
Ltd., 57 Robinson Road, (P. O.
Box 533), Singapore

SWITZERLAND

Bell Telephone Manufacturing Co.,
10 Bubenberplatz, Berne